

# Handbook on International Mobile Telecommunications (IMT)

2022 edition





# **Handbook on International Mobile Telecommunications (IMT)**

**Edition of 2022**

**ITU-R**





## **Preface**

Since the publication of the first edition of this Handbook in 2015, International Mobile Telecommunication (IMT) technologies and applications have advanced so significantly that required the production of a new edition of the Handbook. These developments culminated with the approval by Member States in 2021 of Recommendation ITU-R M.2150 – Detailed specifications of the radio interfaces of International Mobile Telecommunications-2020 (IMT-2020), and its first revision in February 2022. IMT-2020 specifications for the fifth generation of mobile communications (5G) will be the backbone of tomorrow's digital economy, transforming lives and leading industry and society into the automated and intelligent world. 5G will enable much faster data speeds, reliable connectivity, and low latency to international mobile telecommunications (IMT) – all needed for our new global communications ecosystem of connected devices sending vast amounts of data via ultrafast broadband. The successful completion of the evaluation process and the release of this global standard was a significant milestone for the global telecommunication industry and its users. 5G technologies will further enrich the worldwide communications ecosystem, expand the range of innovative applications, and support the burgeoning Internet of Things, including machine-to-machine communication and other innovative applications.

In this new edition of the Handbook, the evolution of IMT applications and global IMT subscriber information have been updated with the latest references including the results of the World Radiocommunication Conference in 2019 (WRC-19) on the identification of frequency spectrum for IMT as reflected in the Radio Regulations in force (Edition of 2020), and the most recent ITU-R Recommendations and Reports on IMT, in particular those on IMT-2020.

Beside thanking the ITU-R experts who contributed to this document, I acknowledge the work of the Study Group Department and that of Mr. Ferran Font Pons in particular, who in 2021 developed the first draft of this new edition of the Handbook before we passed it to Working Party 5D for review and completion.

Mario Maniewicz  
Director, ITU Radiocommunication Bureau

## **Foreword**

This International Telecommunication Union (ITU) Handbook on International Mobile Telecommunications (IMT) is a success story of international cooperation amongst qualified and skilled experts in the field of advanced mobile communications and regulations representing national regulatory agencies, mobile operators and major players in the IMT industry.

Recognizing the rapid progress of IMT, this Handbook may not necessarily contain all aspects of the future development of IMT. However it provides a useful guide to the main features of the current systems and the evolution towards the future. The readers are encouraged to check the latest version of the Handbook's references.

We acknowledge with special thanks the helpful contribution to the discussions of all participants to ITU-R Working Party 5D (WP 5D) and those who have provided useful elements such as data and system parameters of existing IMT systems.

The development of this Handbook has also benefited from the numerous contributions by the participants in the various ITU groups involved, in particular ITU-R WP5D (IMT systems), the group responsible for the ongoing maintenance and updating of the information, which coordinated and reported the works currently ongoing in other groups according to their area of responsibility: ITU-R WP4B (satellite aspects), ITU-T SG 13 (core network aspects), and ITU-D (developing countries aspects).

We believe that this Handbook, together with other ITU publications, will serve as practical tool to assist Administrations and other stakeholders in their endeavours to further develop their IMT networks for the provision of Mobile broadband services.

## TABLE OF CONTENTS

*Page*

Foreword .....	iv
1 Introduction .....	1
1.1 Purpose and scope .....	1
1.2 Vocabulary of key terms used in this Handbook .....	1
2 Usage evolution and service requirements .....	2
2.1 Introduction .....	2
2.2 Usage evolution .....	2
2.3 Market directions .....	6
2.4 Key features of IMT .....	10
2.5 Servicing urban, rural and remote areas .....	11
2.6 Use of IMT for specific applications .....	12
2.7 Considerations for developing countries .....	14
3 IMT system characteristics, technologies and standards .....	16
3.1 Introduction .....	16
3.2 IMT system concepts and objectives .....	16
3.3 IMT architecture and standards .....	18
3.4 Techniques to facilitate roaming .....	41
4 IMT spectrum .....	42
4.1 International spectrum identified for IMT .....	42
4.2 Frequency arrangements .....	43
4.3 Methods to Estimate spectrum requirements for IMT .....	43
5 Regulatory issues .....	45
5.1 Institutional aspects and arrangements .....	45
5.2 Transparency and stakeholder involvement .....	45
5.3 Market knowledge .....	45
5.4 Spectrum licensing .....	45
5.5 IMT spectrum clearing (including re-farming) guidelines .....	46
5.6 Global circulation of terminals .....	46
5.7 Unwanted emissions .....	46
6 Steps to consider in the deployment of IMT systems .....	47
6.1 Key issues and questions to be considered prior to IMT network deployment .....	47
6.2 Migration of existing wireless systems to IMT .....	47
6.3 Choice of technology in the identified IMT bands .....	52

	<i>Page</i>
6.4 Deployment planning.....	53
7 Criteria leading to technology decisions .....	54
7.1 Spectrum implications, channelization and bandwidth considerations.....	54
7.2 Importance of multi-mode/multi-band solutions .....	54
7.3 Technology development path .....	54
7.4 Backhaul considerations .....	54
7.5 Technology neutrality .....	55
ANNEX A – Abbreviations, acronyms, interface and reference points.....	57
A.1 Abbreviations and acronyms.....	57
A.2 Interface .....	61
A.3 Reference point.....	62
ANNEX B – Reference publications.....	65
B.1 ITU publications .....	65
B.2 External publications .....	67
ANNEX C – Applications and services .....	69
C.1 Location based application and services.....	69
ANNEX D – Description of wireless backhaul systems .....	73
ANNEX E – Description of external organizations .....	75
E.1 3GPP .....	75
E.2 3GPP2 .....	75
E.3 IEEE.....	75
ANNEX F – Published Recommendations, Reports and ongoing activities of ITU-R on terrestrial IMT .....	77
F.1 Overview of Recommendations and Reports of ITU-R related to terrestrial IMT .....	77
F.2 Published Recommendations and Reports of ITU-R related to terrestrial IMT .....	88
F.3 Work ongoing and underway in ITU-R WP5D .....	94
F.4 All list of ITU-R Recommendations and Reports on IMT .....	94
ANNEX G – Technology migration in a given frequency band .....	95
G.1 Frequency resource assignments.....	95
G.2 Coexistence between GSM and IMT in the adjacent frequencies .....	98
G.3 Coexistence of various GSM/CDMA-MC/UMTS/LTE technologies in and 900 MHz bands .....	850 101
G.4 Coexistence studies from CEPT between GSM and other systems.....	103



## 1 Introduction

This Handbook identifies International Mobile Telecommunications (IMT) and provides the general information such as service requirements, applications, system characteristics, and substantive information on spectrum, regulatory issues, guideline for the evolution and migration, and core network evolution on IMT.

This Handbook also addresses a variety of issues related to the deployment of IMT systems.

### 1.1 Purpose and scope

The purpose and scope of this Handbook is to provide general guidance to ITU Members, network operators and other relevant parties on issues related to the deployment of IMT systems to facilitate decisions on selection of options and strategies for introduction of their IMT-2000, IMT-Advanced and IMT-2020 networks.

The Handbook focuses on the technical, operational and spectrum related aspects of IMT systems, including information on the deployment and technical characteristics of IMT as well as the services and applications supported by IMT.

This Handbook updates previous information on IMT-2000 and IMT-Advanced. It also includes new information on IMT-2020 from Recommendation ITU-R M.2150. In addition, the work from Report ITU-R M.2243 – Assessment of the global mobile broadband deployments and forecasts for International Mobile Telecommunications, is referenced regarding any future considerations that are identified. This Handbook has been and will continue to be a collaborative effort involving groups in the three ITU Sectors with ITU-R Working Party 5D (WP5D) assuming the lead, coordinating role and responsibility for developing text for the terrestrial aspects; with ITU-R Working Party 4B responsible for the satellite aspects, ITU-T Study Group 13 responsible for the core network aspects and ITU-D responsible for the developing countries aspects.

Special attention has been given to needs of developing countries responding to the first part of Question ITU-R 77/5 which decides that WP5D should continue to study the urgent needs of developing countries for cost effective access to the global telecommunication networks.

### 1.2 Vocabulary of key terms used in this Handbook

Broadband Commission	The Broadband Commission for Digital Development is composed of the International Telecommunication Union (ITU) and the United Nations Educational, Scientific and Cultural Organization (UNESCO). The Commission embraces a range of different perspectives in a multistakeholder approach to promoting the roll-out of broadband, as well as providing a fresh approach to UN and business engagement.
IMT	International Mobile Telecommunication (IMT) encompasses IMT-2000, IMT-Advanced and IMT-2020 collectively based on Resolution ITU-R 56
ITU	International Telecommunication Union
ITU-R	International Telecommunication Union – Radiocommunication Sector
ITU-T	International Telecommunication Union – Telecommunication Standardization Sector
ITU-D	International Telecommunication Union – Telecommunication Development Sector
3GPP	3rd Generation Partnership Project
3GPP2	3rd Generation Partnership Project 2

See also Annex A for a list of abbreviations, acronyms, interface and reference points.

## 2 Usage evolution and service requirements

### 2.1 Introduction

In order to understand current directions in IMT, it is important to consider and understand how mobile broadband is being used and for what purposes (including key features of IMT technologies), and any special requirements of developing countries. Together, these topics provide a foundation upon which to build a stronger understanding of the topics discussed in subsequent sections of this Handbook. The following sections discuss applications (such as mobile Internet usage, video traffic, social networks, and machine-to-machine traffic); market evolution in traffic and devices; key features of each iteration of IMT technologies; the use of IMT to serve urban, rural and remote areas; and considerations for developing countries, such as barriers to access.

### 2.2 Usage evolution

#### 2.2.1 Mobile Internet usage

Mobile Internet usage has been growing rapidly on a worldwide basis over the past years. While the state of mobile Internet usage can be measured in several ways, the growth – and projected growth – is perhaps most striking when considering mobile data traffic volumes and data speeds.

Ericsson, for example, has quantified the total mobile network traffic to 58 EB per month at the end of 2020. The total mobile network traffic is forecast to exceed 300 EB per month in 2026<sup>1</sup>. Adding some perspective to that figure, the authors noted that the increase in mobile data traffic from the second quarter of 2013 to the third quarter exceeded the total monthly mobile data traffic estimated in the fourth quarter of 2009. In the latest one-year period of Ericsson’s analysis, mobile data traffic grew by approximately 80 percent<sup>1</sup>.

In another comparison, the Groupe Speciale Mobile Association (GSMA) noted that more mobile traffic was generated in 2012 than in all other years combined<sup>2</sup>. Looking ahead, mobile devices are expected to continue to outpace other sources of Internet usage. For example, when considering the sources of IP traffic over the world’s telecommunications networks<sup>3</sup> Cisco forecasted that the number of devices connected to IP networks will be more than three times the global population by 2023. There will be 3.6 networked devices per capita by 2023, up from 2.4 networked devices per capita in 2018<sup>3</sup>.

Globally, the total number of Internet users is projected to grow from 3.9 billion in 2018 to 5.3 billion by 2023 at a CAGR of 6 percent. In terms of population, this represents 51 percent of the global population in 2018 and 66 percent of global population penetration by 2023. This rate would be three times faster than fixed traffic over the same period. Smartphone technology and adoption have progressed rapidly in the last several years, providing users with robust, mobile access to broadband services, and comprising the category that will likely make up the bulk of mobile broadband subscriber devices.

---

<sup>1</sup> Ericsson, *Ericsson Mobility Report* (2021), available at <https://www.ericsson.com/en/mobility-report/reports/june-2021>

<sup>2</sup> GSMA, *The Mobile Economy 2021*, available at [https://www.gsma.com/mobileeconomy/wp-content/uploads/2021/07/GSMA\\_MobileEconomy2021\\_3.pdf](https://www.gsma.com/mobileeconomy/wp-content/uploads/2021/07/GSMA_MobileEconomy2021_3.pdf)

<sup>3</sup> Cisco, *Cisco Annual Internet Report (2018–2023)*, available at <https://www.cisco.com/c/en/us/solutions/executive-perspectives/annual-internet-report/index.html>

According to Ericsson's most recent analysis, smartphones accounted for approximately 55 percent of all mobile handsets sold in the third quarter of 2013, while they made up approximately 40 percent of all handsets sold in all of 2012<sup>4</sup>. The analysis also indicated that there is significant room for additional growth, with only 25 to 30 percent of mobile phone subscriptions associated with smartphones.

There will be an additional 1.6 billion smartphone connections by 2025, bringing the overall adoption level to over 80% of total mobile connections.

One analysis indicated that while approximately 5 percent of smartphones were LTE-enabled in July 2011, by August 2013, more than 30 percent could take advantage of LTE networks<sup>5</sup>. Along with the growth in smartphones, the speed of mobile connectivity continues to increase across the world as well as networks and devices implement the latest technologies, such as LTE. Cisco noted that the average mobile network connection speed was 13.2 Mbit/s in 2018 and will be 43.9 Mbit/s by 2023. There are around 8 billion mobile subscriptions. The analysis estimated that this figure will increase to 8.8 billion by the end of 2026, of which 91 percent will be for mobile broadband. Average smartphone data rates are forecast to triple by 2017, reaching 6.5 Mbit/s<sup>6</sup>. There is anecdotal evidence to support the idea that usage increases when speed increases, although there may be a delay between the increase in network and device speed and the resultant increased usage, potentially a lag of several years.

### 2.2.2 Mobile software application offerings (Apps)

A key driver of mobile data usage has been the rapid proliferation of software applications, commonly known as "apps", for use on smartphones and other mobile devices (see also Annex C for examples of applications and communication services). Taking into consideration the two largest app ecosystems, there were approximately 900 000 apps available for iOS (the operating system that powers Apple's iPhone, iPad and iPod devices) and approximately 800 000 apps available for Android (the operating system for a wide range of mobile handsets and tablet devices). There is likely substantial overlap between the ecosystems, with many developers releasing applications for both operating systems in order to reach the largest potential customer bases. Both ecosystems have seen fairly steady growth in recent years, although the rate of growth for Android applications has increased recently. Application download estimates vary widely.

ABI Research estimated that there would be a total of 56 billion smartphone apps downloaded in 2013 (including not just iOS and Android, but also Windows Phone and Blackberry), while Portio Research estimated that 82 billion apps would be downloaded worldwide in 2013. Regardless of the exact number, it is worth noting that this mobile app downloads are a relatively new phenomenon, having begun in earnest with the launch of Apple's App Store in 2008.

Similarly, the number of apps downloaded has increased rapidly. For example in 2010, an estimated five billion iOS apps and 289,000 Android apps were downloaded, as compared to an estimated 48 billion iOS apps and 50 billion Android apps in early 2013. Applications are generally grouped into certain categories, with analysts parsing network traffic to identify the amount of traffic generated by each group, as well as to forecast future traffic patterns. In particular, Ericsson expected that video content would continue to drive mobile data usage, representing more than 50 percent of traffic by 2019.

---

<sup>4</sup> Ericsson, *Ericsson Mobility Report* (2021), available at <https://www.ericsson.com/en/mobility-report/reports/june-2021>

<sup>5</sup> Global Mobile Suppliers Association, "LTE: user device segmentation: 2011-2013" (2013), available at <https://gsacom.com/paper/lte-user-devices/>.

<sup>6</sup> Cisco, Cisco Annual Internet Report, available at <https://www.cisco.com/c/en/us/solutions/executive-perspectives/annual-internet-report/index.html>

As mobile network speeds and capacity continue to increase, mobile software applications are expanding to take advantage of both. A GSMA and A.T. Kearny analysis forecasted that mobile data traffic would grow at a CAGR of 66 percent between 2012 and 2017, reaching a monthly rate of 11 156 petabytes<sup>7</sup>. The GSMA analysis predicted that several services would experience CAGR of more than 30 percent over the 2012-2017 period: VoIP (34 percent), gaming (62 percent), M2M (89 percent), file sharing (34 percent), data (55 percent) as well as video (75 percent). The following sections examine some of these important drivers in more detail.

### 2.2.3 Video traffic

As noted in section 2.2.1, mobile data traffic has been growing at a rapid pace, and is expected to continue to do so. The major driver of this growth is expected to be mobile video, which has been predicted to account for more than 7 000 petabytes of monthly data traffic by 2017<sup>7</sup>. Ericsson forecasted that mobile video traffic will increase at an average annual rate of 55 percent through 2019. Video traffic currently accounts for 66 percent of all mobile data traffic, a share that is forecast to increase to 77 percent in 2026<sup>8</sup>.

As a result, according to one analysis, as many as 41 percent of people between the ages of 65 and 69 stream video content over fixed or mobile networks on at least a weekly basis<sup>9</sup>. One possible development that may drive additional mobile video traffic is gaming. While currently, the data traffic volumes and speed requirements of many single or multi-player games available on mobile devices are relatively low, there is some expectation that this situation will change in the future<sup>9</sup>. As more games adopt elements such as multi-player features, high-definition content and video streaming, gaming may become a more important driver of video traffic.

### 2.2.4 Social networks on mobile

Back in 2013, social networking was estimated to account for approximately 10 percent of total mobile data traffic<sup>9</sup>. Ericsson further estimated that this share would remain constant through 2019, although social networking usage would increasingly include more data-rich content, such as photographs and video<sup>9</sup>. When considering how people use their mobile devices, social networking was already the second-largest generator of data traffic volume. Between 2012 and 2013, Ericsson noted an increase in the percentage of social networking traffic on smartphones<sup>9</sup>.

Importantly, the use of mobile handsets for social networking far exceeds such use on tablets and laptops, where the percentage of mobile data traffic generated by social networking is below five percent, as shown in Figure 1.

---

<sup>7</sup> GSMA, *The Mobile Economy 2021*, available at [https://www.gsma.com/mobileeconomy/wp-content/uploads/2021/07/GSMA\\_MobileEconomy2021\\_3.pdf](https://www.gsma.com/mobileeconomy/wp-content/uploads/2021/07/GSMA_MobileEconomy2021_3.pdf)

<sup>8</sup> Ericsson, *Ericsson Mobility Report* (2021), available at <https://www.ericsson.com/en/mobility-report/reports/june-2021>.

<sup>9</sup> Ericsson, *Ericsson Mobility Report: On the Pulse of the Networked Society* (2013) at 15, available at <http://www.ericsson.com/res/docs/2013/ericsson-mobility-report-november-2013.pdf>.

FIGURE 1

## Application mobile data traffic volumes by device type (2013)

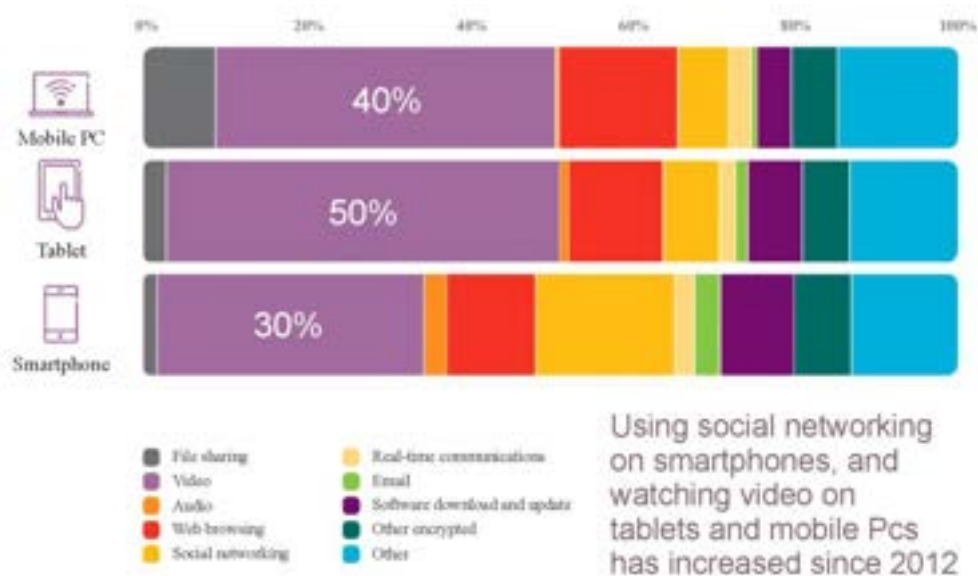

IMT-01

Considering how smartphone users spend time on their devices, Google data from 41 countries indicated that more than half of all smartphone users use social networking at least monthly, and more than 25 percent do so daily<sup>10</sup>. In 27 of those countries, more than 75 percent of smartphone users access social networks at least monthly. An Ericsson analysis showed that social networking is the most popular activity among iOS and Android smartphone users in the United States of America, accounting for 13.1 hours per month<sup>11</sup>. The next most popular smartphone use in this analysis was entertainment, which was responsible for 8.5 hours of use per month.

### 2.2.5 Machine-to-machine traffic

As mobile network coverage and capacity has expanded, and the cost of embedding connectivity into various types of equipment has declined, the number of Internet-connected devices has grown rapidly. Many of these devices are expected to continuously monitor some sort of situation or status, report information to users, and/or communicate with each other. Depending on the definition used, M2M communications can include a wide range of devices, such as remote sensors, “smart” electricity grids, Internet-connected appliances and automobiles, and manufacturing equipment, just to name a few.

M2M connections will be half of the global connected devices and connections by 2023. The share of Machine-To-Machine (M2M) connections will grow from 33 percent in 2018 to 50 percent by 2023. There will be 14.7 billion M2M connections by 2023<sup>12</sup>.

Within the M2M connections category (which is also referred to as IoT), connected home applications will have the largest share, and connected car will be the fastest growing application type. Connected home applications will have nearly half or 48 percent of M2M share by 2023 and connected car applications will grow the fastest at 30 percent CAGR over the forecast period (2018-2023).

<sup>10</sup> Google, “Our Mobile Planet”, available at <http://www.thinkwithgoogle.com/mobileplanet/en/>

<sup>11</sup> Ericsson, *Ericsson Mobility Report* (June 2021), available at <https://www.ericsson.com/en/mobility-report/reports/june-2021>

<sup>12</sup> Cisco Annual Internet Report (2018–2023) White Paper, available at <https://www.cisco.com/c/en/us/solutions/executive-perspectives/annual-internet-report/index.html>

## 2.2.6 Other drivers of future data traffic

Back in 2011, the demand for mobile cloud services was expected to grow exponentially since the users are increasingly adopting more services that are required to be accessible. The consequence is that the volume of mobile content they generate cumulatively grows. Multimedia services captured on mobile devices will overwhelmingly carry the greatest cloud computing and storage demand and since then, the average size of these media files grew substantially as camera pixel resolution continues to increase (ARC Chart<sup>13</sup> predicted that mobile-generated content will consume 9 400 PB of cloud services by 2015).

Furthermore, cloud services are getting a lot of attention since, among other benefits, they save costs for enterprises. These cloud services require guaranteed data communication between the clients and the connected data centres hosting IT servers. As the number of mobile users connecting through the mobile network to the cloud increase, the mobile data traffic will continuously grow.

As mobile software applications advance due to increasing processing power, mobile data traffic is expected to increase<sup>14</sup>.

The cloud architecture is a relevant evolution of the provisioning of digital services and applications that has to be considered when planning for the evolution of IMT technologies. Economic underpinnings of all these technological developments is the ability to move data across borders to facilitate a number of key functions such as; communication, information, content, e-commerce, M2M, etc. But even more the realities behind the productions of mentioned functions e.g. the presence of global value chains must be recognized. This means that in the B2B market, today's complex ICT systems that are required to realize these new technologies and functions rely on the ability of companies to develop, produce, integrate, manage and support these systems from multiple territories and hence the ability to collaborate and exchange data across territories is absolutely essential.

## 2.3 Market directions

### 2.3.1 Global IMT subscriber information from 2020 to 2026

According to the ITU, the number of active mobile-broadband subscriptions stood at 75 per 100 inhabitants in 2020.<sup>15</sup>

The number of active mobilebroadband subscriptions per 100 inhabitants continues to grow strongly, with an 18.4 per cent year-on-year growth. Eventhough, annual growth has been slowing down gradually since 2017, and 2020 coverage is only 1.3 percentage points higher than 2019.

The ITU also noted in 2013 that the number of mobile broadband subscriptions in developing countries had more than doubled since 2011, from 472 million to 1.16 billion, surpassing the number of subscriptions in developed countries<sup>16</sup>.

There is still a substantial penetration gap between the developed and developing countries, however. According to the ITU, there is 122 active mobile-broadband subscriptions of every 100 developed country inhabitants, as compared to 75 of every 100 inhabitants in developing countries<sup>15</sup>.

---

<sup>13</sup> ARC Chart Research Report on the mobile cloud: Market analysis and forecasts, June 2011.

<sup>14</sup> Report ITU-R M.2243 – Assessment of the global mobile broadband deployments and forecasts for International Mobile Telecommunications, section 3.10.

<sup>15</sup> ITU, “Measuring digital development: Facts and Figures ” (2020), available at <https://www.itu.int/en/ITU-D/Statistics/Documents/facts/FactsFigures2020.pdf>

<sup>16</sup> ITU, “Measuring digital development: Facts and Figures ” (2020), available at [https://www.itu.int/en/ITU-D/Statistics/Documents/facts/FactsFigures2019\\_r1.pdf](https://www.itu.int/en/ITU-D/Statistics/Documents/facts/FactsFigures2019_r1.pdf)



As noted by the Broadband Commission in its 2013 Report, *The State of Broadband 2013: Universalizing Broadband*, mobile broadband subscriptions surpassed fixed broadband subscriptions in 2008, and have shown an annual growth rate of approximately 30 percent<sup>17</sup>. That classifies mobile broadband as having, according to the Broadband Commission, the highest growth rate of any ICT, exceeding fixed broadband subscriptions by a ratio of 3:1 (up from 2:1 in 2010).

When considering the growth of IMT subscriptions, rapid growth is expected over the next several years. Ericsson data, illustrated in Figure 2, indicated that the majority of subscriptions were LTE devices in North America and Western Europe in 2013, while the majority of mobile subscriptions will be comprised between LTE and 5G<sup>18</sup> devices in all regions of the world by 2026<sup>19</sup>.

FIGURE 2

### Mobile subscriptions by region and technology, 2020 and 2026

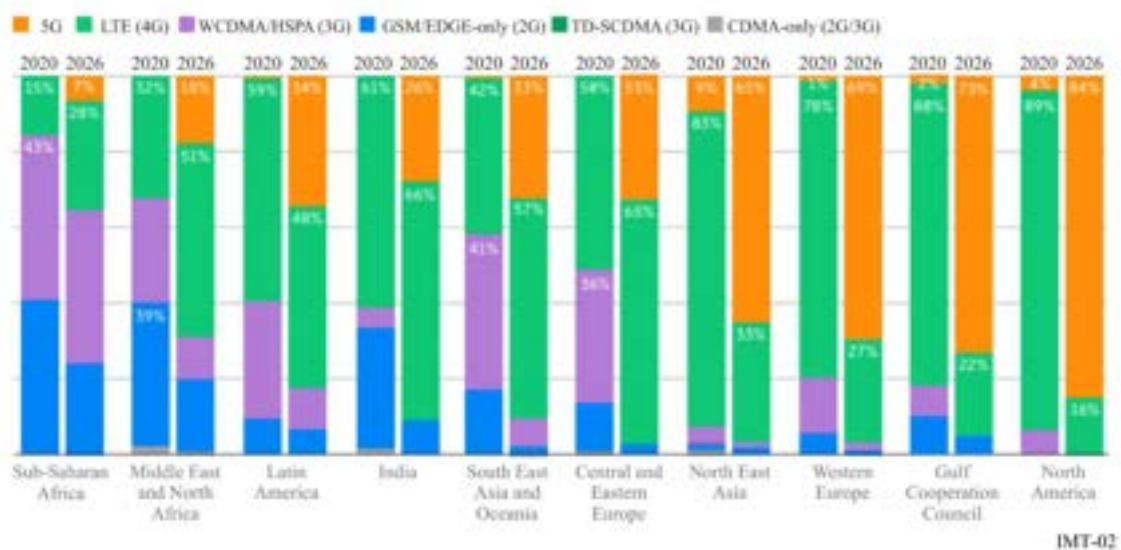

IMT-02

### 2.3.2 Device type

As mobile broadband connectivity continues to spread and also to increase its capacity and speeds, a growing number of device types have been developed to serve differing user needs. When considering devices supporting 5G, for example, the Global Mobile Suppliers Association (GSA) announced that the number of 5G devices has continued to grow, reaching 873, an increase of 24.2% over the first quarter of 2021. Of these announced 5G devices, 63.8% are understood to be commercially available. The number of commercial 5G devices has grown by 29.2% over the last quarter, to reach 557 commercial 5G devices<sup>20</sup>. Tablets, personal hotspots and routers are also fast-growing segments of the device ecosystem.

<sup>17</sup> Broadband Commission, *The State of Broadband: Tackling Digital Inequalities* (2020), available at <https://www.broadbandcommission.org/publication/the-state-of-broadband-2020/>

<sup>18</sup> This Handbook includes the terms 3G, 4G and 5G commonly used by the industry to refer to IMT-2000, IMT-Advanced and IMT-2020, respectively.

<sup>19</sup> Ericsson, *Ericsson Mobility Report* (June 2021), available at <https://www.ericsson.com/4a03c2/assets/local/reports-papers/mobility-report/documents/2021/june-2021-ericsson-mobility-report.pdf>

<sup>20</sup> Global Mobile Suppliers Association, *5G Devices: Executive Summary – July 2021*, available at <https://gsacom.com/reports/GSA-5G-Device-Ecosystem-ES-July-2021.pdf>

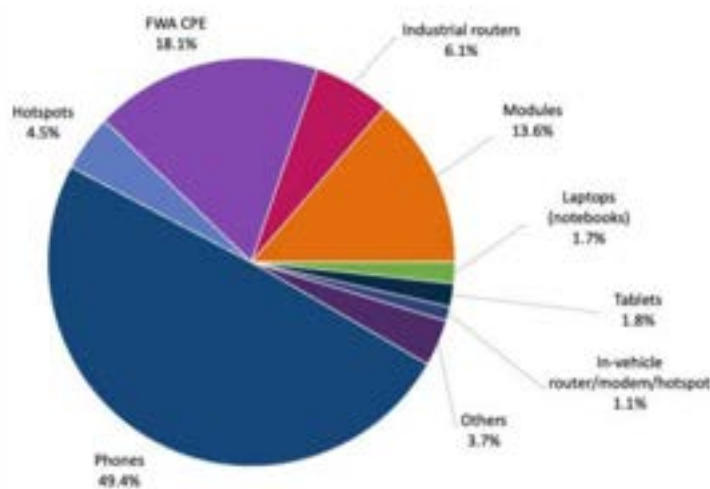

According to GSMA, by the end of 2020, 5.2 billion people subscribed to mobile services, representing 67% of the global population. Adding new subscribers is increasingly difficult, as markets are becoming saturated and the economics of reaching rural populations are becoming more difficult to justify in a challenging financial climate for mobile operators. That said, their analysis estimated that there will be nearly half a billion new subscribers by 2025, taking the total number of subscribers to 5.7 billion (70% of the global population)<sup>21</sup>.

The growth in smartphone subscriptions was forecast to come primarily as users exchange their basic phones for smartphones in Africa, Asia and the Middle East over the next several years, due in part to the availability of lower-cost devices. Laptops, tablets and mobile router subscriptions were expected to continue to grow as well, from 300 million in 2013 to 800 million in 2019. Ericsson also predicted significant regional differences, with smartphones comprising almost all handsets sold in Western Europe and North America in 2019, compared to 50 percent of handset subscriptions in the Middle East and Africa<sup>22</sup>.

### 2.3.3 Network and user experience improvement

As mobile data traffic demand continues to grow, mobile network operators are spending heavily to upgrade their networks in order to increase their capacity and improve the user experience. One analysis estimated that operators would spend USD 8.7 billion on LTE network upgrades alone in 2012, rising to USD 24 billion in 2013 and USD 36 billion by 2015.<sup>23</sup>

One of the most commonly considered measures of user experience is average mobile network speed. According to Cisco back in 2014, speeds increase across all regions and all device types between then and 2017<sup>24</sup>. Globally, the average mobile network connection speed in 2012 was 526 kbit/s. This average was expected to grow at a CAGR of 49 percent, and to exceed 3.9 Mbit/s in 2017.

<sup>21</sup> GSMA, *The Mobile Economy 2021*, available at [http://www.gsma-mobileeconomy.com/GSMA\\_Global\\_Mobile\\_Economy\\_Report\\_2021.pdf](http://www.gsma-mobileeconomy.com/GSMA_Global_Mobile_Economy_Report_2021.pdf)

<sup>22</sup> Ericsson, *Ericsson Mobility Report* (June 2021), available at <https://www.ericsson.com/4a03c2/assets/local/reports-papers/mobility-report/documents/2021/june-2021-ericsson-mobility-report.pdf>

<sup>23</sup> IHS, *LTE Expected to Dominate Wireless Infrastructure Spending by 2013* (January 2012).

<sup>24</sup> Cisco, *The Zettabyte Era – Trends and Analysis* (2014), available at [http://www.cisco.com/c/en/us/solutions/collateral/service-provider/visual-networking-index-vni/VNI\\_Hyperconnectivity\\_WP.html](http://www.cisco.com/c/en/us/solutions/collateral/service-provider/visual-networking-index-vni/VNI_Hyperconnectivity_WP.html)



Across all regions, Cisco estimated that average mobile data speeds increase at a CAGR of at least 36 percent through 2017, with the Middle East and Africa increasing at a CAGR of 68 percent.

IMT technology has become widespread in global mobile networks. With the commercialization of LTE technology in recent years, operators are rapidly moving to upgrade their networks. By the end of 2026, 5G will account for 40.8% of the global market (at 4.62 billion subscriptions), although LTE will still represent the biggest share of the market at 46.8% of all global mobile subscriptions.

The evolution of IMT systems has continuously increased the data rates available to mobile broadband users. Technologies have continued to increase peak data speeds with each iteration and new technology.

Advances in technology alone, however, sometimes cannot support the rapid growth rates that are being seen in mobile data use. This is particularly true in urban areas around the world. Thus, operators and regulators worldwide are trying to make additional spectrum available for mobile broadband, particularly by making new bands of spectrum available. For example, the transition from analogue to digital television broadcasting can result in a “digital dividend” of spectrum that was formerly used for broadcasting but that now can be made available for other uses. Most countries around the world have either started a process to make that spectrum available for mobile broadband or are planning to do so. The majority of such transitions are expected to be completed in the next ten years.

### 2.3.4 Policy initiatives to promote mobile broadband

Governments and multilateral organizations are taking a variety of approaches to promote mobile broadband such as the development of National Broadband Plan. While each country faces unique challenges to increasing mobile broadband adoption, certain general approaches can be applied in many cases. Mobile broadband initiatives are often developed as subsets of plans intended to increase broadband adoption more generally. As such, policy approaches that may improve mobile broadband adoption may closely track those approaches employed to increase fixed broadband adoption.

In other cases, as in many developing countries, mobile broadband is the primary (or only) broadband option available to many individuals and communities. Policy approaches intended to increase mobile broadband supply can include:

- setting concrete, measurable objectives for improving the supply of broadband through infrastructure build-out, including deployment of and upgrades to mobile networks;
- ensuring availability and efficient use of spectrum for mobile services, including flexible spectrum use;
- ensuring competitive, efficient and transparent markets;
- ensuring equitable access to broadband for all; and
- encouraging investment in mobile networks, services and applications.

One of these approaches is to promote the deployment of mobile networks operating in frequency bands below 1 GHz, as the main solution to facilitate provision of broadband mobile services in unserved areas.

Policy approaches intended to increase demand for mobile broadband can include:

- promoting demand for broadband services and applications;
- considering if there is a need for, and an appropriate mechanism to deliver, subsidies for devices and/or service fees, perhaps through a universal access or universal service program;
- making useful information and services available to mobile device users (e.g. m-government, m-health, m-banking); and
- educating users and potential users on the benefits of mobile broadband-enabled services.

The Broadband Commission, while not focusing on mobile broadband specifically, recently proposed policy approaches intended to improve access to broadband that are applicable to the mobile sector. For example, the Commission’s 2013 report, as part of its goal of universalizing broadband, suggested establishing adequate spectrum policies and reasonable spectrum allocations, as well as ensuring stable legal and regulatory

frameworks to foster and incentivize investments, and creating an environment for sustainable competition<sup>25</sup>. In the same discussion, the report noted the importance of establishing a national broadband plan to guide broadband development. Among the other Broadband Commission policy recommendations applicable to mobile services are to focus on making broadband affordable and to improve penetration, which will go hand-in-hand.

The first Broadband Commission report, *A 2010 Leadership Imperative: The Future Built on Broadband*, noted among its recommendations the need for national policy objectives to include the provision of broadband-enabled services and applications for vulnerable, disadvantaged and remote populations, among others.<sup>26</sup> Particularly with respect to remote populations, mobile technology provides a key means – and perhaps the only economically feasible means – by which to reach these groups.

## **2.4 Key features of IMT**

### **2.4.1 Key features of IMT-2000**

Key features of IMT-2000 are:

- high degree of commonality of design worldwide;
- compatibility of services within IMT-2000 and with the fixed networks;
- high quality;
- small terminal for worldwide use;
- worldwide roaming capability;
- capability for multimedia applications, and a wide range of services and terminals.

Recommendation ITU-R M.1457 identifies the IMT-2000 terrestrial radio interface specifications. These radio interfaces support the features and design parameters of IMT-2000, including the above mentioned features, such as capability to ensure worldwide compatibility, international roaming, and access to high-speed data services.

### **2.4.2 Key features of IMT-Advanced**

Key features of IMT-Advanced are:

- high degree of commonality of functionality worldwide while retaining the flexibility to support a wide range of services and applications in a cost-efficient manner;
- compatibility of services within IMT and with fixed networks;
- capability of interworking with other radio access systems;
- high-quality mobile services;
- user equipment suitable for worldwide use;
- user-friendly applications, services and equipment;
- worldwide roaming capability;
- enhanced peak data rates to support advanced services and applications (100 Mbit/s for high and 1 Gbit/s for low mobility)<sup>27</sup>.

These features enable IMT-Advanced to address evolving user needs.

---

<sup>25</sup> Broadband Commission, *The State of Broadband 2013: Universalizing Broadband* (2013), available at <http://www.broadbandcommission.org/Documents/bb-annualreport2013.pdf>

<sup>26</sup> Broadband Commission, *A 2010 Leadership Imperative: The Future Built on Broadband* (2010), available at [http://www.broadbandcommission.org/Documents/publications/Report\\_1.pdf](http://www.broadbandcommission.org/Documents/publications/Report_1.pdf)

<sup>27</sup> Data rates sourced from Recommendation ITU-R M.1645.

Recommendation ITU-R M.2012 identifies the terrestrial radio interface technologies of IMT-Advanced and provides the detailed radio interface specifications. These radio interface specifications detail the features and parameters of IMT-Advanced, including the above mentioned features, such as the capability to ensure worldwide compatibility, international roaming, and access to high-speed data services.

### 2.4.3 Key features of IMT-2020

Key features of IMT-2020 are:

- compatibility of services within IMT and with fixed networks;
- capability of interworking with other radio access systems;
- high-quality mobile services;
- worldwide roaming capability;
- low to high mobility applications;
- machine type communications;
- ultra-reliable and low latency communications;
- high-quality multimedia applications.

Recommendation ITU-R M.2150 identifies and provides the detailed specifications of the radio interfaces for the terrestrial component of IMT-2020 and provides the detailed radio interface specifications. These radio interface specifications detail the feature and parameters of IMT-2020, including the above mentioned features, such as worldwide compatibility, international roaming, and access to the services under diverse usage scenarios, including enhanced mobile broadband (eMBB), massive machine type communications (mMTC) and ultrareliable and low latency communications (URLLC).

#### 2.4.3.1 Usage scenarios for IMT-2020 and beyond

IMT-2020 and beyond is envisaged to expand and support diverse usage scenarios and applications that will continue beyond the current IMT. Furthermore, a broad variety of capabilities would be tightly coupled with these intended different usage scenarios and applications for IMT-2020 and beyond. The usage scenarios for IMT-2020 and beyond include:

- **Enhanced Mobile Broadband:** Mobile Broadband addresses the human-centric use cases for access to multimedia content, services and data. The demand for mobile broadband will continue to increase, leading to eMBB. The eMBB usage scenario will come with new application areas and requirements in addition to existing Mobile Broadband applications for improved performance and an increasingly seamless user experience. This usage scenario covers a range of cases, including wide-area coverage and hotspot, which have different requirements. For the hotspot case, i.e. for an area with high user density, very high traffic capacity is needed, while the requirement for mobility is low and user data rate is higher than that of wide area coverage. For the wide area coverage case, seamless coverage and medium to high mobility are desired, with much improved user data rate compared to existing data rates. However, the data rate requirement may be relaxed compared to hotspot.
- **Ultra-reliable and low latency communications:** This use case has stringent requirements for capabilities such as throughput, latency and availability. Some examples include wireless control of industrial manufacturing or production processes, remote medical surgery, distribution automation in a smart grid, transportation safety, among others.
- **Massive machine type communications:** This use case is characterized by a very large number of connected devices typically transmitting a relatively low volume of non-delaysensitive data. Devices are required to be low cost, and have a very long battery life.

## 2.5 Servicing urban, rural and remote areas

A number of Mobile Broadband (MBB) systems and applications, based on different standards, are available and the suitability of each depends on usage (fixed vs. nomadic/mobile), and performance and geographic requirements, among others. In countries where wired infrastructure is not well established, MBB systems can

be more easily deployed to deliver services to population bases in dense urban environments as well as those in more remote areas. Some users may only require broadband Internet access for short-ranges whereas other users may require broadband access over longer distances. Moreover, these same users may require that their MBB applications be nomadic, mobile, fixed or a combination of all three.

In sum, there are a number of multi-access solutions, and the choice of which to implement will depend on the interplay of requirements, the use of various technologies to meet these requirements, the availability of spectrum (licensed vs. unlicensed), and the scale of network required for the delivery of MBB applications and services (local vs. metropolitan area networks)<sup>28</sup>.

### 2.5.1 Fixed wireless access (FWA) in the mobile service

As technology has improved, operators have been turning to mobile networks to deliver residential and business broadband services. GSA has undertaken a study to determine the extent and nature of fixed wireless access broadband service availability based on LTE or 5G technologies around the world<sup>29</sup>.

Operators worldwide are investing in fixed wireless access (FWA) in the form of lab trials, acquisition of licences, field-based pilot projects, network deployments, or commercial service launches. GSA estimates there are at least 460 operators investing in FWA based on LTE or 5G. Of those, GSA has identified available service offers for FWA using LTE or 5G from 436 operators in 171 countries/territories; that equates to more than half of all operators with commercial LTE or 5G networks worldwide. As a result, by 2030 it is expected that 5G FWA subscriptions to approach 130 million with annual revenues of USD 53 billion.

5G Americas has published a white paper entitled “Fixed Wireless Access with 5G Networks”, which details how FWA might impact the broadband market with attractive opportunities for 5G based residential service in both urban and rural geographies<sup>30</sup>.

5G FWA can eliminate the need for costly deployment of fixed access infrastructure while also offering significant peak download and upload rates. As 5G networks evolve, FWA solutions are expected to achieve massive scale, with 10 to 100 times more capacity than 4G networks. Additionally, the white paper provides deployment considerations for mobile operators regarding spectrum availability of low, mid and mmWave band spectrum. It describes how physical location, small cell siting and other considerations can impact FWA and how capacity, product speeds, 5G New Radio technologies involving beamforming and high order modulation and customer premise equipment strategy will play a vital role in its rollout to customers.

## 2.6 Use of IMT for specific applications

In this Handbook, the use of IMT for specific applications is considered. Some other applications can be considered in the future if appropriate.

### 2.6.1 Use of IMT for PPDR applications

Report ITU-R M.2291 addresses the current and possible future use of international mobile telecommunications (IMT) including the use of long term evolution (LTE) in support of broadband PPDR communications as outlined in relevant ITU-R Resolutions, Recommendations and Reports. The Report further provides examples for deploying IMT for PPDR radiocommunications, case studies and scenarios of IMT systems to support broadband PPDR applications such as data and video. PPDR is defined in Resolution **646 (Rev.WRC-19)** through a combination of the terms ‘public protection radiocommunication’ and ‘disaster relief radiocommunication’. The first term refers to “radiocommunications used by responsible agencies and organizations dealing with maintenance of law and order, protection of life and property and

---

<sup>28</sup> LMH-BWA.

<sup>29</sup> Global mobile Suppliers Association (GSA), FWA Global Status Update – June 2021, available at <https://gsacom.com/paper/fwa-global-status-update-june-2021/>

<sup>30</sup> 5G Americas, “Fixed Wireless Access with 5G Networks”, November 2021, available at: <https://www.5gamericas.org/fixed-wireless-access-with-5g-networks/>

emergency situations”. The second term refers to “radiocommunications used by agencies and organizations dealing with a serious disruption of the functioning of society, posing a significant widespread threat to human life, health, property or the environment, whether caused by accident, natural phenomena or human activity, and whether developing suddenly or as a result of complex, long-term processes”. A number of studies of PPDR radiocommunications have been carried out within the ITU, based on Resolution **646 (Rev.WRC-19)** and Report ITU-R M.2377.

### **2.6.2 Use of IMT for MTC applications**

Report ITU-R M.2440 addresses the technical and operational aspects of terrestrial IMT-based radio networks and systems supporting machine type communication (MTC) applications, as well as spectrum needed, including possible harmonized use of spectrum to support the implementation of narrowband and broadband MTC infrastructure and devices.

Globally, the importance of developing reliable and cost effective MTC solutions for various industries is increasing on a daily basis. Examples of these solutions include smart energy management, agriculture, water management, waste management, health, transportation and utilities that may have a direct impact on social and economic development.

MTC has wide range of narrowband and broadband applications based on each use case. Some use cases of broadband MTC include sensors (including health monitoring as an example), actuators and cameras with a wide range of characteristics and demands. Several use cases for MTC require a narrowband connection as well as wide coverage area and low power consumption.

### **2.6.3 Use of IMT for audio-visual services**

Report ITU-R M.2373 – Audio-visual capabilities and applications supported by terrestrial IMT systems, examines the capabilities of IMT systems to deliver audio-visual services to consumers. A IMT is expected to complement traditional broadcasting systems (cable, satellite or terrestrial delivery) or other broadband services (fixed internet access or RLAN) to satisfy consumer demand for audio-visual services, in particular with respect to personalization, portability, easy to use, and mobility.

Today, audio-visual services over IMT (for both linear and on-demand audio-visual content) represent a small percentage of total audio-visual content consumption; however, it is expected that audio-visual over IMT will increase in the future and that it will be the major traffic contributor in IMT networks. Offering audio-visual services over IMT already contributes to national safety and security, economies and social development by enabling a range of applications, such as social media, distance learning, health and entertainment. Furthermore it could further contribute to the reduction of the digital divide between urban areas and rural areas or certain underserved communities. Socio-economic demands are already driving requirements for access to audio-visual services and applications, for users to experience similar quality of experience (QoE), including coverage and data rates in rural and urban areas.

### **2.6.4 Vertical industries**

Verticals are defined as companies, industries and public sector organisations operating in a specific sector. Vertical industries have long relied on various wireless technologies and spectrum bands to support their connectivity needs.

However, the requirements of vertical networks are evolving – most notably from voice to high-speed data. Some verticals want networks that support low power wide area IoT for connecting smart meters and sensors, while others want networks that support very low latencies for advanced manufacturing including robotics. The importance of connectivity has created pressures for wide area coverage (e.g. utilities) and/or highly localised connectivity (e.g. manufacturing plants) as well as high levels of reliability including for safety of life applications (e.g. emergency services, hospitals, etc).

Given the needs of different verticals, there have been efforts to categorise complementary scenarios and specific applications in order to assess the network and spectrum requirements.

### **2.6.5 Use of IMT for transport applications**

Report ITU-R M.2441 – Emerging usage of the terrestrial component of International Mobile Telecommunication (IMT), provides information on various use cases and specific applications such as:

- Transportation applications such as Intelligent Transport Systems (ITS), railways or high speed train communication and bus/fleet traffic management
- Utilities such as smart grids and water management
- Industrial automation applications such as motion control, mobile control panels with safety functions, mobile robots, massive wireless sensor networks, remote access and maintenance, augmented reality, process automation, flexible, modular assembly area, “Plug and produce” for field devices
- Applications for Remote control of machines such as for high-quality communication links, mining applications, construction sites, harbours
- Surveying and inspection in oil and gas fields and electricity distribution
- Electricity
- Healthcare applications such as remote surgery and clinical wearables
- Mobile health applications

ITU-R WP5D is also developing a new Report on use of IMT-2020 for various industrial, enterprise and societal applications.

### **2.7 Considerations for developing countries**

IMT and mobile phones have long surpassed fixed connections in most developing countries, and many broadband services in developing countries are being delivered by IMT. For some people in developing countries, their first and only access to the Internet will be via an IMT device.

Such connectivity, combined with affordable IMT smart phones, provides opportunities to empower individuals across society. For example, with IMT devices, doctors are remotely monitoring cardiac patients in rural villages; farmers are accessing weather information and sales prices to increase their income and improve their standard of living; women entrepreneurs are lifting themselves out of poverty by harnessing the economic benefits of wireless to start businesses and access banking services; and children everywhere can access educational content in and out of the classroom, 24 hours a day. While we are seeing tremendous benefits in key areas such as education, healthcare and commerce, more needs to be done in many social areas to support development agenda. The IMT smart phone is the most largely implemented technological platform in history, and its potential to significantly improve people’s lives is just starting to be realized.

Advantages of M2M (Machine-to-machine) applications and IOT (Internet of things) enabled through IMT networks can also help developing countries bridge the digital divide.

The 2013 Annual Broadband Commission Report (Table 3, Source: Inter-American Development Bank) contains a list of special requirements/barriers faced by developing countries and offers examples of strategies to overcome such barriers.

**Barriers to access and public policies to overcome barriers**

<b>Barrier/obstacle</b>	<b>Examples of strategies to overcome the barriers</b>
1 Low levels of purchasing power in certain rural and sub-urban areas	<ul style="list-style-type: none"> <li>• Subsidies to the benefit of end-users, to ensure broadband adoption, once access is secured</li> <li>• Discounted offers from operators to end-users</li> <li>• Telecentres for shared use to kick- start broadband markets</li> <li>• Public-private partnerships (PPPs)</li> </ul>
2 Limited financial resources available via some USFs	<ul style="list-style-type: none"> <li>• Policy-makers should work with operators, depending on local needs and government funding, to ensure USF is properly sourced and effective</li> <li>• Support (e.g. from international agencies) for ad-hoc projects</li> <li>• Priority given to UAS projects based on strict and clear criteria</li> </ul>
3 The low levels of ICT skills of some of the population	<ul style="list-style-type: none"> <li>• ICT training</li> <li>• Connecting up educational establishments</li> <li>• ICT lessons in schools and universities, and</li> <li>• ICT equipment furnished at low or no cost</li> </ul>
4 The lack of basic commodities (water, electricity, etc.)	<ul style="list-style-type: none"> <li>• Telecentres open to the public where access to commodities is guaranteed</li> <li>• Wi-Fi access in public spaces where access to commodities is guaranteed</li> </ul>
5 The limited availability of consumer electronic equipment	<ul style="list-style-type: none"> <li>• Distribution of equipment directly, or subsidies for consumer electronic equipment by poor households</li> <li>• Review import duty regimes to ensure they are effective</li> <li>• Equipment approval (supply) policies should not be too onerous or restrictive</li> </ul>
6 High tax rates on telecom services or equipment	<ul style="list-style-type: none"> <li>• Targeted tax and import duty reductions on broadband services and devices, including removal of luxury taxes</li> </ul>
7 Lack of infrastructure/ high costs of deployment	<ul style="list-style-type: none"> <li>• National broadband plan, including roll-out of a mutualized national backbone, as well as in-building infrastructure</li> <li>• Grants to operators to build out infrastructure</li> <li>• Sharing of infrastructure and works</li> </ul>
8 Administrative delays in authorizations to deploy new infrastructure	<ul style="list-style-type: none"> <li>• Involve relevant agencies and Ministries early</li> <li>• Streamline licensing procedures</li> <li>• Eliminate red-tape and delays</li> <li>• Remove barriers and obstacles to owning land</li> </ul>
9 Limited economic growth in certain areas	<ul style="list-style-type: none"> <li>• Ongoing subsidy programs on the demand side, following investment on the supply side</li> </ul>
10 Limitations in amount of spectrum available	<ul style="list-style-type: none"> <li>• Streamline spectrum licensing and re-farming practices</li> <li>• Implementation of the digital switch-over</li> <li>• More effective policies for spectrum allocation/assignment</li> </ul>
11 Limited availability of relevant local content	<ul style="list-style-type: none"> <li>• Subsidies and awards for the development of local content</li> <li>• Development of e-government services, open government/freedom of information policies</li> </ul>

In addition, ITU-D Report “Access technology for broadband telecommunications including IMT, for developing countries”<sup>31</sup> provides developing countries with an understanding of the different technologies available for broadband access in urban, rural and remote areas using both wired and wireless technologies for terrestrial and satellite telecommunications, including IMT. The Report covers technical issues involved in deploying broadband access technologies by identifying the factors influencing the effective deployment of such technologies, as well as their applications, with a focus on technologies and standards that are recognized or under study within ITU-R and ITU-T.

<sup>31</sup> ITU-D Report “Access technology for broadband telecommunications including IMT, for developing countries”, available at <http://www.itu.int/pub/D-STG-SG02.25-2014>

### 3 IMT system characteristics, technologies and standards

#### 3.1 Introduction

International Mobile Telecommunications (IMT) encompasses IMT-2000, IMT-Advanced and IMT-2020 collectively based on Resolution ITU-R 56.

The capabilities of IMT systems are being continuously enhanced in line with user application demands and technology developments.

Recommendation ITU-R M.1457 contain the detailed specifications of the terrestrial radio interface of IMT-2000. Recommendations ITU-R M.2012 and ITU-R M.2150 contains, respectively, the detailed specifications of the terrestrial radio interfaces of IMT-Advanced and IMT-2020.

#### 3.2 IMT system concepts and objectives

##### IMT system concepts

IMT-2000, third generation mobile systems started service around the year 2000, and IMT systems provide access by means of one or more radio links to a wide range of telecommunication services including advanced mobile services, supported by fixed networks (e.g. PSTN/Internet), which are increasingly packet-based, and other services specific to mobile users.

It is described in Recommendation ITU-R M.1645 that the framework of the future development of IMT-2000 and systems beyond IMT-2000 for the radio access network is based on the global user application demands and technology evolution directions, including the needs of developing countries.

International Mobile Telecommunications – Advanced (IMT-Advanced) is a mobile system that includes the new capabilities of IMT that go beyond those of IMT-2000.

The term “IMT-Advanced” is applied to those systems, system components, and related aspects that include new radio interface(s) that support the new capabilities of systems beyond IMT-2000<sup>32</sup>.

IMT-Advanced systems provide enhanced peak data rates to support advanced services and applications (100 Mbit/s for high and 1 Gbit/s for low mobility were established as targets for research)<sup>33</sup>.

IMT-Advanced systems have capabilities for high-quality multimedia applications within wide range of services and platforms, providing a significant improvement in performance and quality of current services, and support low to high mobility applications and a wide range of data rates in accordance with user and service demands in multiple user environments.

The capabilities of IMT-Advanced systems are being continuously enhanced in line with technology developments.

The global operation and economy of scale are key requirements for the success of mobile telecommunication systems. It is desirable to agree on a harmonized time-frame for developing common technical, operational and spectrum-related parameters of systems, taking account of relevant IMT-2000 and other experience.

Maximizing the commonality between IMT-Advanced air interfaces may lead to reduced complexity and a lower incremental cost of multi-mode terminals.

---

<sup>32</sup> As described in Recommendation ITU-R M.1645, systems beyond IMT-2000 will encompass the capabilities of previous systems, and the enhancement and future developments of IMT-2000 that fulfil the criteria in *resolves 2* of Resolution ITU-R 56 may also be part of IMT-Advanced.

<sup>33</sup> Data rates sourced from Recommendation ITU-R M.1645.



### 3.2.1 Capabilities of IMT-2020

IMT-2020 systems are mobile systems that include the new capabilities of IMT that go beyond those of IMT-Advanced. IMT-2020 systems support low to high mobility applications and a wide range of data rates in accordance with user and service demands in multiple user environments. IMT-2020 also has capabilities for high quality multimedia applications within a wide range of services and platforms, providing a significant improvement in performance and quality of service.

A broad variety of capabilities, tightly coupled with intended usage scenarios and applications for IMT-2020 is envisioned. Different usage scenarios along with the current and future directions will result in a great diversity/variety of requirements. The key design principles are flexibility and diversity to serve many different use cases and scenarios, for which the capabilities of IMT-2020, described in the following paragraphs, will have different relevance and applicability. In addition, the constraints on network energy consumption and the spectrum resource will need to be considered.

IMT-2020 should be able to provide these capabilities without undue burden on energy consumption, network equipment cost and deployment cost to make future IMT sustainable and affordable.

The key capabilities of IMT-2020 are shown in Figure 3, compared with those of IMT-Advanced.

FIGURE 3

#### Enhancement of key capabilities from IMT-Advanced to IMT-2020

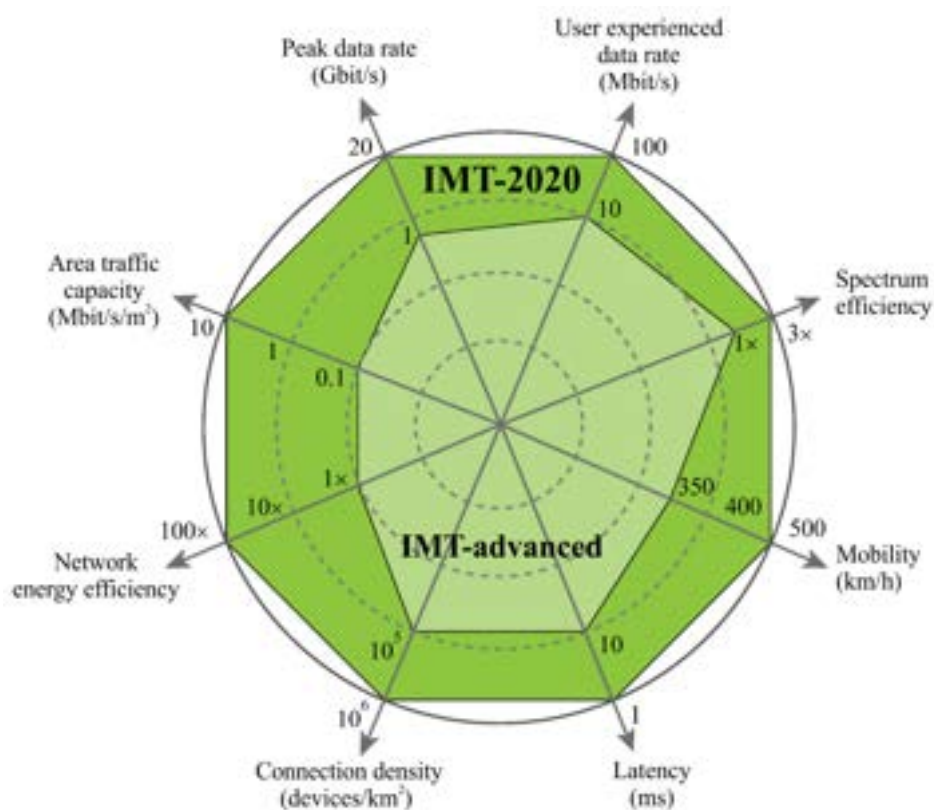

IMT-03

#### Objectives

Objectives of IMT-2000 are defined in Recommendation ITU-R M.687 – International Mobile Telecommunications-2000 (IMT-2000), and were finally revised in 1997, including general objectives, technical objectives, and operational objectives. For more details please refer to the original Recommendation.

Objectives for IMT for 2020 and beyond are established in Recommendation ITU-R M.2083, by describing potential user and application directions, growth in traffic, technological evolution and spectrum implications, and by providing guidelines on the framework and the capabilities for IMT for 2020 and beyond.

Objectives of the future development of IMT-2000 and systems beyond IMT-2000 are also summarized in Recommendation ITU-R M.1645 from the view point of multiple perspectives as in the next table taken from section 4.2.2 of Recommendation ITU-R M.1645 as follows:

#### Objectives from multiple perspectives

Perspective	Objectives
END USER	<ul style="list-style-type: none"> <li>Ubiquitous mobile access</li> <li>Easy access to applications and services</li> <li>Appropriate quality at reasonable cost</li> <li>Easily understandable user interface</li> <li>Long equipment and battery life</li> <li>Large choice of terminals</li> <li>Enhanced service capabilities</li> <li>User-friendly billing capabilities</li> </ul>
CONTENT PROVIDER	<ul style="list-style-type: none"> <li>Flexible billing capabilities</li> <li>Ability to adapt content to user requirements depending on terminal, location and user preferences</li> <li>Access to a very large marketplace through a high similarity of application programming interfaces</li> </ul>
SERVICE PROVIDER	<ul style="list-style-type: none"> <li>Fast, open service creation, validation and provisioning</li> <li>Quality of service (QoS) and security management</li> <li>Automatic service adaptation as a function of available data rate and type of terminal</li> <li>Flexible billing capabilities</li> </ul>
NETWORK OPERATOR	<ul style="list-style-type: none"> <li>Optimization of resources (spectrum and equipment)</li> <li>QoS and security management</li> <li>Ability to provide differentiated services</li> <li>Flexible network configuration</li> <li>Reduced cost of terminals and network equipment based on global economies of scale</li> <li>Smooth transition from IMT-2000 to systems beyond IMT-2000</li> <li>Maximization of sharing capabilities between IMT-2000 and systems beyond IMT-2000</li> <li>Single authentication (independent of the access network)</li> <li>Flexible billing capabilities</li> <li>Access type selection optimizing service delivery</li> </ul>
MANUFACTURER/ APPLICATION DEVELOPER	<ul style="list-style-type: none"> <li>Reduced cost of terminals and network equipment based on global economies of scale</li> <li>Access to a global marketplace</li> <li>Open physical and logical interfaces between modular and integrated subsystems</li> <li>Programmable platforms that enable fast and low-cost development</li> </ul>

### 3.3 IMT architecture and standards

Recommendation ITU-R M.1645 defines the framework and overall objectives of the future development of IMT-2000 and systems beyond IMT-2000 for the radio access network based on the global user application demands and technology evolution directions, and the needs of developing countries.

Since the year of 2000, the technical specifications of IMT-2000 have been continually enhanced.

IMT-2000, IMT-Advanced and IMT-2020 are defined by a set of interdependent ITU Recommendations which are referred to in this Handbook.

There are a number of other ITU-R Recommendations for IMT (Recommendations ITU-R M.1036, ITU-R M.1580, ITU-R M.1581 and ITU-R M.1579 among others) that provide relevant implementation aspects enabling the most effective and efficient use and deployment of systems – while minimizing the impact on other systems or services in these and in adjacent bands – and facilitating the growth of IMT systems<sup>34</sup>.

For more information on ITU-R Recommendations and Reports please refer to Annex B.

### 3.3.1 IMT radio access network and standards

Recommendation ITU-R M.1457 provides the detailed specifications of the terrestrial radio interfaces of IMT-2000. Recommendations ITU-R M.2012 and ITU-R M.2150 provide, respectively, the detailed specifications of the terrestrial radio interfaces of IMT-Advanced and IMT-2020. These Recommendations provide specific information regarding the air interfaces that are used in the terrestrial IMT networks.

Recommendation ITU-R M.1457 contains overviews and detailed specifications of each of the IMT-2000 radio interfaces:

- (Section 5.1) IMT-2000 CDMA Direct Spread
- (Section 5.2) IMT-2000 CDMA Multi-Carrier
- (Section 5.3) IMT-2000 CDMA TDD
- (Section 5.4) IMT-2000 TDMA Single-Carrier
- (Section 5.5) IMT-2000 FDMA/TDMA
- (Section 5.6) IMT-2000 OFDMA TDD WMAN.

Recommendation ITU-R M.2012 contains detailed specifications of the terrestrial radio interfaces of IMT-Advanced. The Recommendation includes both overviews and detailed specifications of the two IMT-Advanced radio interfaces:

- (Annex 1) Specification of the LTE-Advanced radio interface technology.
- (Annex 2) Specification of the WirelessMAN-Advanced radio interface technology.

Recommendation ITU-R M.2150 contains detailed specifications of the terrestrial radio interfaces of IMT-2020. The Recommendation includes both overviews and detailed specifications of the three IMT-2020 radio interfaces:

- (Annex 1) Specification of the 3GPP 5G-SRIT radio interface technology.
- (Annex 2) Specification of the 3GPP 5G-RIT radio interface technology.
- (Annex 3) Specification of the 5Gi radio interface technology.
- (Annex 4) Specification of the DECT 5G – SRIT radio interface technology.

---

<sup>34</sup> Recommendations ITU-R M.1457, ITU-R M.2012 and ITU-R M.2150 are separate, independent, and self-contained Recommendations, each one with a specific scope. These Recommendations will evolve independently, and there could be some overlap reflected by commonality in content between the documents.

### 3.3.1.1 IMT-2000

#### 3.3.1.1.1 IMT-2000 CDMA direct spread

This section includes CDMA Direct Spread and E-UTRAN.

#### CDMA direct spread

The IMT-2000 radio-interface specifications for CDMA direct spread technology are developed by a partnership of SDOs<sup>35</sup>. This radio interface is called Universal Terrestrial Radio Access (UTRA) FDD or Wideband CDMA (WCDMA).

The overall architecture of the radio access network is shown in Figure 4. The architecture of this radio interface consists of a set of radio network subsystems (RNS) connected to the core network (CN) through the Iu interface. An RNS consists of a radio network controller (RNC) and one or more entities called Node B. Node B is connected to the RNC through the Iub interface. Each NodeB can handle one or more cells. The RNC is responsible for the handover decisions that require signalling to the user equipment (UE). In case macro diversity between different Node Bs is to be supported, the RNC comprises a combining/splitting function to support this. Node B can comprise an optional combining/splitting function to support macro diversity within a Node B. The RNCs of the RNS can be interconnected through the Iur interface. Iu and Iur are logical interfaces, i.e. the Iur interface can be conveyed over a direct physical connection between RNCs or via any suitable transport network.

FIGURE 4

**Radio access network architecture**  
(Cells are indicated by ellipses)

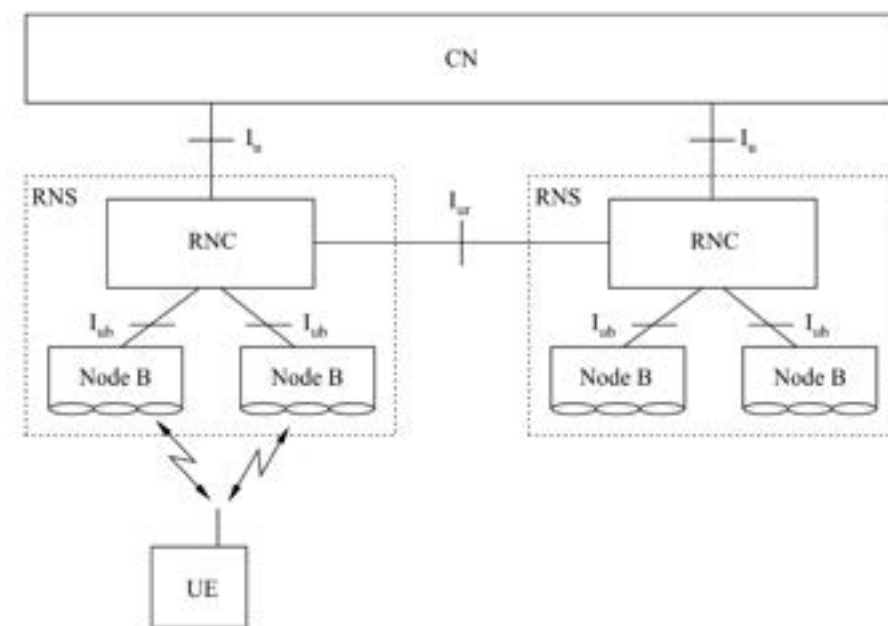

IMT-04

<sup>35</sup> Currently, these specifications are developed within the third generation partnership project (3GPP) where the participating SDOs are the Association of Radio Industries and Businesses (ARIB), China Communications Standards Association (CCSA), the European Telecommunications Standards Institute (ETSI), Alliance for Telecommunications Industry Solutions (ATIS Committee T1P1), Telecommunications Technology Association (TTA), Telecommunication Technology Committee (TTC) and Telecommunications Standards Development Society, India (TSDSI).

### E-UTRAN (Evolved Universal Terrestrial Radio Access Network = LTE)

E-UTRAN has been introduced for the evolution of the radio-access technology towards a high-data-rate, low-latency and packet-optimized radio-access technology.

E-UTRAN supports scalable bandwidth operation below 5 MHz bandwidth options up to 20 MHz in both the uplink and downlink. Harmonization of paired and unpaired operation is highly considered to avoid unnecessary fragmentation of technologies.

The radio access network architecture of E-UTRAN consists of the evolved UTRAN Node Bs (eNBs). eNBs host the functions for radio resource management, IP header compression and encryption of user data stream, etc. eNBs are interconnected with each other and connected to an Evolved Packet Core (EPC).

The E-UTRAN radio access network consists of eNBs, providing the user plane (PDCP/RLC/MAC/PHY) and control plane (RRC) protocol terminations towards the UE. The eNBs are interconnected with each other by means of the X2 interface. The eNBs are also connected by means of the S1 interface to the EPC (Evolved Packet Core), and more specifically to the MME (Mobility Management Entity) by means of the S1-C and to the S-GW (Serving Gateway) by means of the S1-U. The S1 interface supports a many-to-many relation between MMEs/Serving Gateways and eNBs.

The E-UTRAN radio access network architecture is illustrated in Figure 5.

FIGURE 5

#### Overall architecture

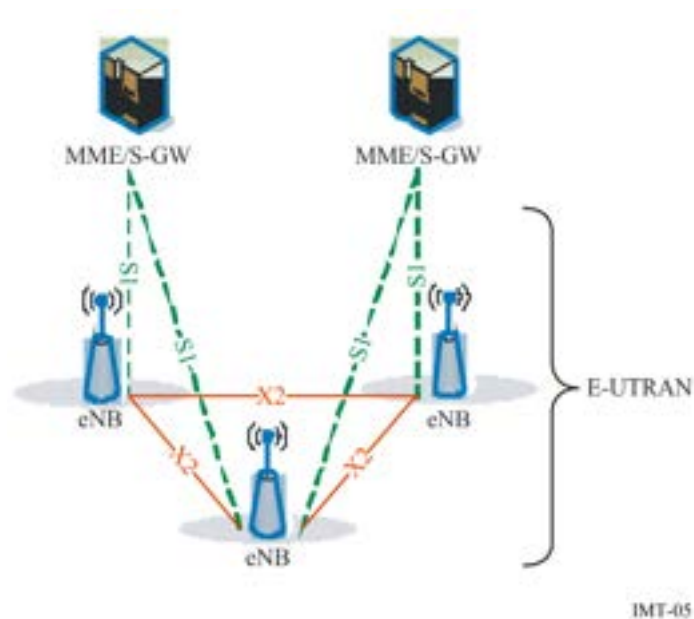

The eNB hosts the following functions:

- functions for Radio Resource Management: Radio Bearer Control, Radio Admission Control, Connection Mobility Control, Dynamic allocation of resources to UEs in both uplink and downlink (scheduling);
- IP header compression and encryption of user data stream;
- selection of an MME at UE attachment;
- routing of User Plane data towards S-GW;
- scheduling and transmission of paging messages (originated from the MME);
- scheduling and transmission of broadcast information (originated from the MME or O&M);
- measurement and measurement reporting configuration for mobility and scheduling.

The MME hosts the following functions:

- NAS signalling;
- NAS signalling security;
- Inter CN node signalling for mobility between 3GPP access networks;
- Idle mode UE Reachability (including control and execution of paging retransmission);
- Tracking Area list management (for UE in idle and active mode);
- PDN GW and Serving GW selection;
- MME selection for handovers with MME change;
- SGSN selection for handovers to GSM or IMT-2000 3GPP access networks;
- Roaming;
- Authentication;
- Bearer management functions including dedicated bearer establishment.

#### **3.3.1.1.2 IMT-2000 CDMA Multi-Carrier**

The IMT-2000 radio interface specifications for CDMA multi-carrier (MC) technology are developed by a partnership of SDOs (3GPP2)<sup>36</sup>. This radio interface is called cdma2000.

##### **cdma2000 1xRTT and High Rate Packet Data (HRPD) Access Network Architecture**

Figures 6 and 7 below show the relationship among network components in support of Mobile Station (MS) originations, MS terminations, and direct Base Station (BS) to Base Station (BS) soft/softer handoff operations. These two Figures also depict a logical architecture that does not imply any particular physical implementation. The InterWorking Function (IWF) for circuit-oriented data calls is assumed to be located at the circuit-switched Mobile Switching Centre (MSC), and the SDU (Selection/Distribution Unit) function is considered to be co-located with the source BSC (Base Station Controller).

---

<sup>36</sup> Currently, these specifications are developed within the Third Generation Partnership Project 2 (3GPP2), where the participating SDOs are ARIB, CCSA, TIA, TTA and TTC.

FIGURE 6

Reference model for circuit-switched cdma2000 access network interfaces

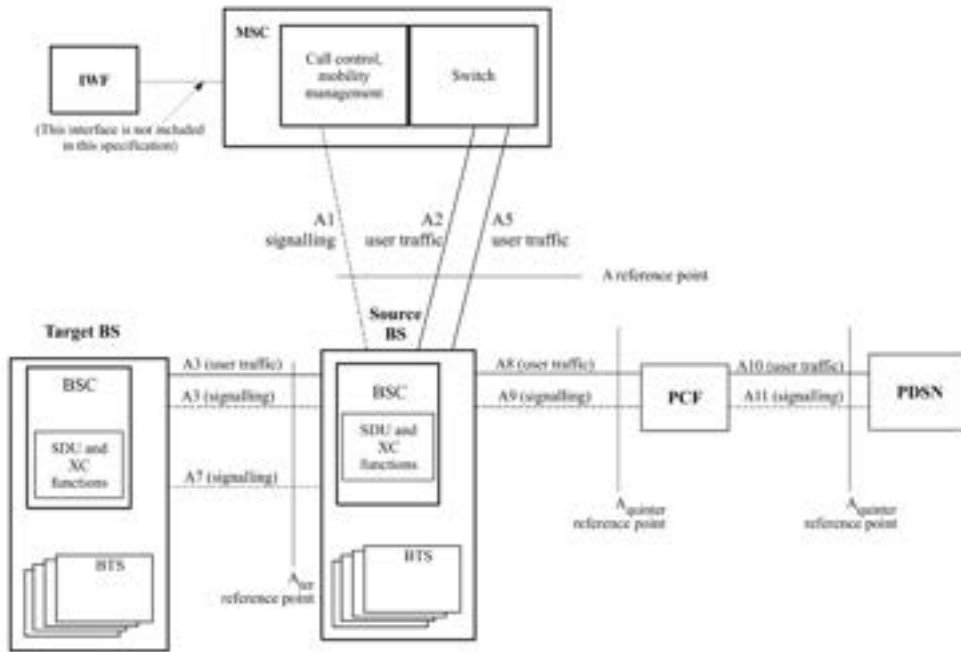

IMT-06

FIGURE 7

Reference model for packet-based cdma2000 access network interfaces

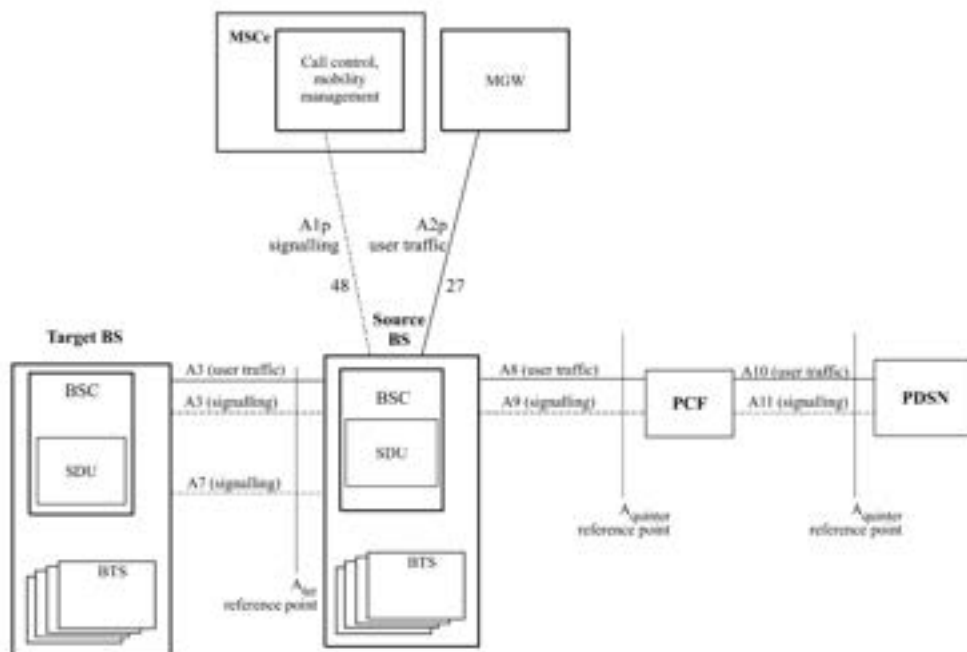

IMT-07

The interfaces defined in Figures 6 and 7 provide:

- bearer (user traffic) connections (A2, A2p, A3 (traffic), A5, A8, and A10);
- a signalling connection between the channel element component of the target BS and the SDU function in the source BS (A3 signalling);
- a direct BS to BS signalling connection (A7);
- a signalling connection between the BS and the circuit-switched MSC (A1);
- a signalling connection between the BS and the MSCe (A1p);
- a signalling connection between the BS and PCF (A9); and
- a signalling connection between a PCF and PDSN pair (A11). A11 signalling messages are also used for passing accounting related and other information from the PCF to the PDSN.

In general, the functions specified on the interfaces are based on the premise that the interfaces carry signalling information that traverses the following logical paths:

- between the BS and MSC only (e.g. BS management information);
- between the MS and the MSC via the BS (e.g. the BS maps air interface messages to the A1 or A1p interface);
- between the BS and other network elements via the MSC;
- between the source BS and the target BS;
- between the BS and the PCF;
- between the PCF and the PDSN; and
- between the MS and the PDSN (e.g. authorization information and Mobile Internet Protocol (MIP) signalling).

### **cdma2000 Evolved High Rate Packet Data (eHRPD) Access Network Architecture**

The eHRPD IOS (Interoperability Specification) messaging and call flows are based on the Architecture Reference Model shown in Figure 8<sup>37</sup> and in Figure 9<sup>38</sup>. In these Figures, solid lines indicate signalling and bearer and dashed lines indicate only signalling.

The eHRPD call flows include the E-UTRAN and other 3GPP access entities (S-GW, P-GW, HSS and PCRF). Refer to TS 23.402<sup>39</sup> for the architecture model and descriptions of these network entities and associated interfaces.

---

<sup>37</sup> The Interworking Solution (IWS) Function in Figure 8 may be collocated at either the 1x Base Station (BS) or at the HRPD eAN, or may be a standalone entity. When the IWS function is collocated at the 1x BS, the A21 interface is supported between the 1x BS and the HRPD eAN, and the A1/A1p interface is supported between the Mobile Switching Centre (MSC) and the 1x BS. When the IWS function is part of the HRPD eAN, the A1/A1p interface between the MSC and the HRPD eAN exists, and the A21 interface is internal to the HRPD eAN. When the IWS is a standalone entity, the A1/A1p interface is supported between the MSC and the IWS, and the A21 interface is supported between the IWS and the HRPD eAN. PDSN and HSGW functions may not be in the same physical entity.

<sup>38</sup> The IWS Function in Figure 9 may be collocated at either the 1x BS or at the HRPD ePCF, or may be a standalone entity. When the IWS function is collocated at the 1x BS, the A21 interface is supported between the 1x BS and the HRPD ePCF, and the A1/A1p interface is supported between the MSC and the 1x BS. When the IWS function is part of the HRPD ePCF, the A1/A1p interface between the MSC and the HRPD ePCF exists, and the A21 interface is internal to the HRPD ePCF. When the IWS is a standalone entity, the A1/A1p interface is supported between the MSC and the IWS, and the A21 interface is supported between the IWS and the HRPD ePCF. PDSN and HSGW functions may not be in the same physical entity.

<sup>39</sup> 3GPP TS 23.402 V12.7.0 (2014-12), Technical Specification Group Services and System Aspects; Architecture enhancements for non-3GPP accesses.



FIGURE 8

Session control and mobility management in the evolved access network

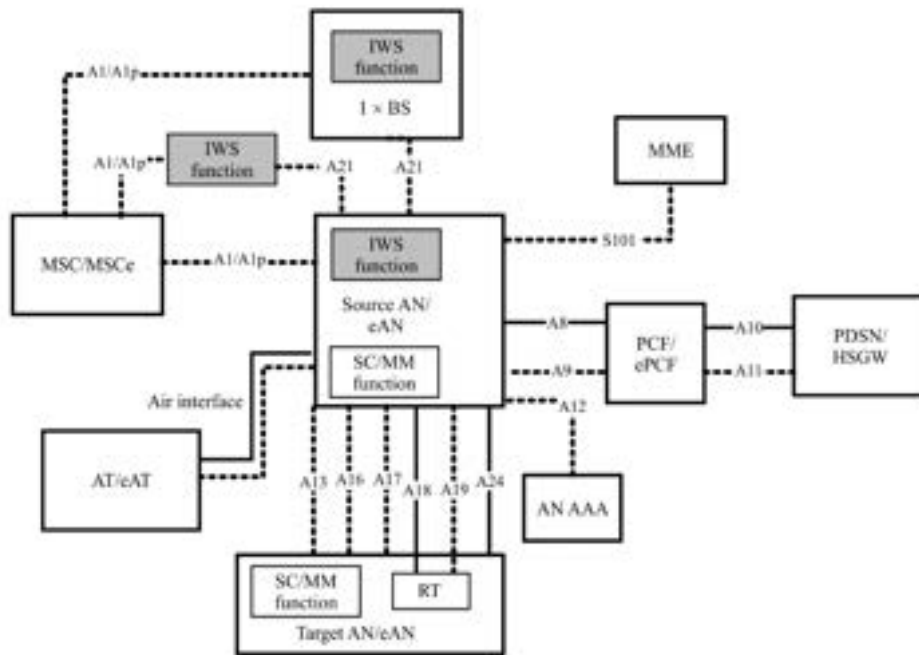

IMT-08

FIGURE 9

Session control and mobility management in the evolved packet control function

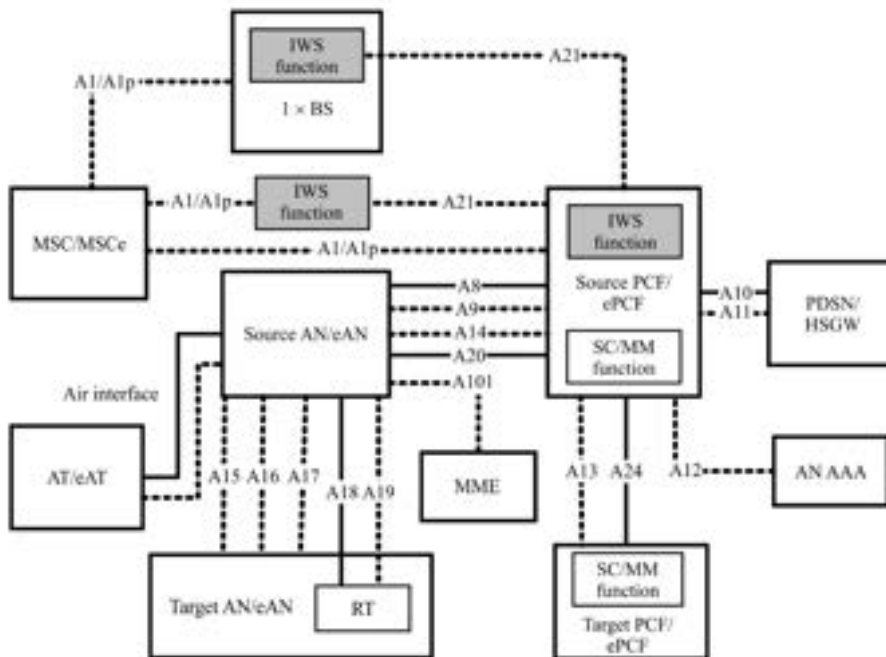

IMT-09

### 3.3.1.1.3 IMT-2000 CDMA TDD

The IMT-2000 radio interface specifications for CDMA TDD technology are developed by a partnership of standards development organizations (SDOs)<sup>40</sup>. This radio interface is called the Universal Terrestrial Radio Access (UTRA) time division duplex (TDD), where three options, called 1.28 Mchip/s TDD (TD-SCDMA)<sup>41</sup>, 3.84 Mchip/s TDD and 7.68 Mchip/s TDD can be distinguished. E-UTRAN TDD has been introduced for the evolution of UTRAN TDD towards high data rate, low latency and packet optimized radio access technology.

For the IMT-2000 CDMA TDD RAN overall architecture please refer to Figure 4 above. For the E-UTRA TDD RAN overall architecture please refer to Figure 5.

### 3.3.1.1.4 IMT-2000 TDMA single-carrier

The IMT-2000 TDMA single-carrier radio interface specifications contain two variations depending on whether a TIA/EIA-41 circuit switched network component or a GSM evolved UMTS circuit switched network component is used. In either case, a common enhanced GSM General Packet Radio Service (GPRS) packet switched network component is used.

#### Radio interface use with TIA/EIA-41 circuit switched network

The IMT-2000 radio interface specifications for TDMA single-carrier technology utilizing the TIA/EIA-41 circuit switched network component are developed by TIA TR45.3 with input from the Universal Wireless Communications Consortium. This radio interface is called Universal Wireless Communication-136 (UWC-136), which is specified by American National Standard TIA/EIA-136. It has been developed with the objective of maximum commonality between TIA/EIA-136 and GSM EDGE GPRS.

This radio interface was designed to provide a TIA/EIA-136 (designated as 136)-based radio transmission technology that meets ITU-R's requirements for IMT-2000. It maintains the TDMA community's philosophy of evolution from 1<sup>st</sup> to 3<sup>rd</sup> Generation systems while addressing the specific desires and goals of the TDMA community for a 3<sup>rd</sup> Generation system.

#### Radio interface used with GSM evolved UMTS circuit switched network component

This radio interface provides an evolution path for an additional pre-IMT-2000 technology (GSM/GPRS) to IMT-2000 TDMA Single-Carrier. The IMT-2000 radio interface specifications for TDMA Single-Carrier technology utilizing the GSM evolved UMTS circuit switched network component are developed by 3GPP and transposed by ATIS Wireless Technologies and Systems Committee (WTSC). The circuit switched component uses a common 200 kHz carrier as does the GSM EDGE enhanced GPRS phase 2 packet switched component, as used by 136EHS, to provide high speed data (384 kbit/s). In addition a new dual carrier configuration is supported

#### TIA/EIA-41 Circuit Switched Network component

Figure 10 presents the network elements and the associated reference points that comprise a system utilizing the TIA/EIA-41 circuit switched network component. The primary TIA/EIA-41 network node visible to the serving GPRS support node (SGSN) is the gateway mobile switching centre (MSC)/visitor location register (VLR). The interface between the TIA/EIA-41 gateway MSC/VLR and the SGSN is the Gs' interface, which allows the tunnelling of TIA/EIA-136 signalling messages between the MS and the gateway MSC/VLR. The tunnelling of these signalling messages is performed transparently through the SGSN. Between the MS and the SGSN, the signalling messages are transported using the tunnelling of messages (TOM) protocol layer. TOM uses the LLC unacknowledged mode procedures to transport the signalling messages. Between the SGSN and the gateway MSC/VLR, the messages are transported using the BSSAP+ protocol.

<sup>40</sup> Currently, these specifications are developed within the third generation partnership project (3GPP) where the participating SDOs are ARIB, ATIS, CCSA, ETSI, TSDSI, TTA and TTC.

<sup>41</sup> The same name TD-SCDMA was previously used for one of the original proposals that was further refined following the harmonization process.

Upon receiving a TIA/EIA-136 signalling message from a MS via the TOM protocol, the SGSN forwards the message to the appropriate gateway MSC/VLR using the BSSAP+ protocol. Upon receiving a TIA/EIA-136 signalling message from a gateway MSC/VLR via the BSSAP+ protocol, the SGSN forwards the message to the indicated MS using the TOM protocol.

MS supporting both the TIA/EIA-41 circuit-switched network component and packet services (Class B136 MS) perform location updates with the circuit system by tunnelling the registration message to the gateway MSC/VLR. When an incoming call arrives for a given MS, the gateway MSC/VLR associated with the latest registration pages the MS through the SGSN. The page can be a hard page (no Layer 3 information included in the message), in which case, the Gs' interface paging procedures are used by the MSC/VLR and the SGSN. If the circuit page is not for a voice call or, if additional parameters are associated with the page, a Layer 3 page message is tunneled to the MS by the MSC/VLR. Upon receiving a page, the MS pauses the packet data session and leaves the packet data channel for a suitable DCCH. Broadcast information is provided on the packet control channel to assist the MS with a list of candidate DCCHs. Once on a DCCH, the MS sends a page response. The remaining call setup procedures, such as traffic channel designation, proceed as in a normal page response situation.

FIGURE 10

TIA/EIA-41 circuit switched network components

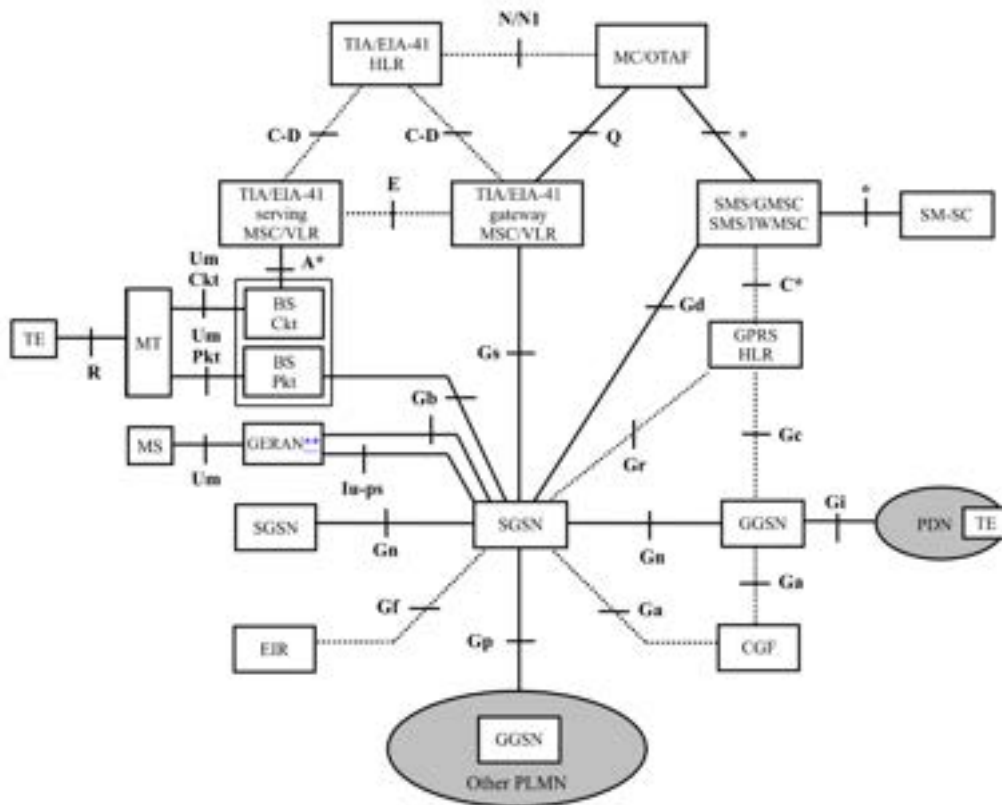

- Signalling
- Signalling and Data Transfer Interface
- \*\* GERAN in this context is the union of GSM, GPRS and EDGE
- Notes:
  - For simplicity, not all network elements of TIA/EIA-41 and ETSI GPRS are shown.
  - Interfaces labeled with \* are implementation specific.
  - Interface C\* is as defined in ETSI TS 129 002 [35].

**GSM evolved UMTS Circuit Switched Network component**

Figure 11 presents the network elements and the associated reference points that comprise a system utilizing the GSM evolved UMTS circuit switched network component along with the common GSM EDGE enhanced GPRS or EGPRS2 packet switched component.

Since the TDMA-SC network supports a common EDGE 136EHS bearer connected to a core enhanced GPRS backbone network or a GSM EDGE radio access network, along with either circuit switched component, GSM EDGE Release 5, Release 6, Release 7 and Release 8 mobile stations and functions are supported. In addition to the Gs interface, GSM SMS functionality is also supported through the Gd interface<sup>42</sup>.

FIGURE 11

**GSM evolved UMTS circuit switched network component**

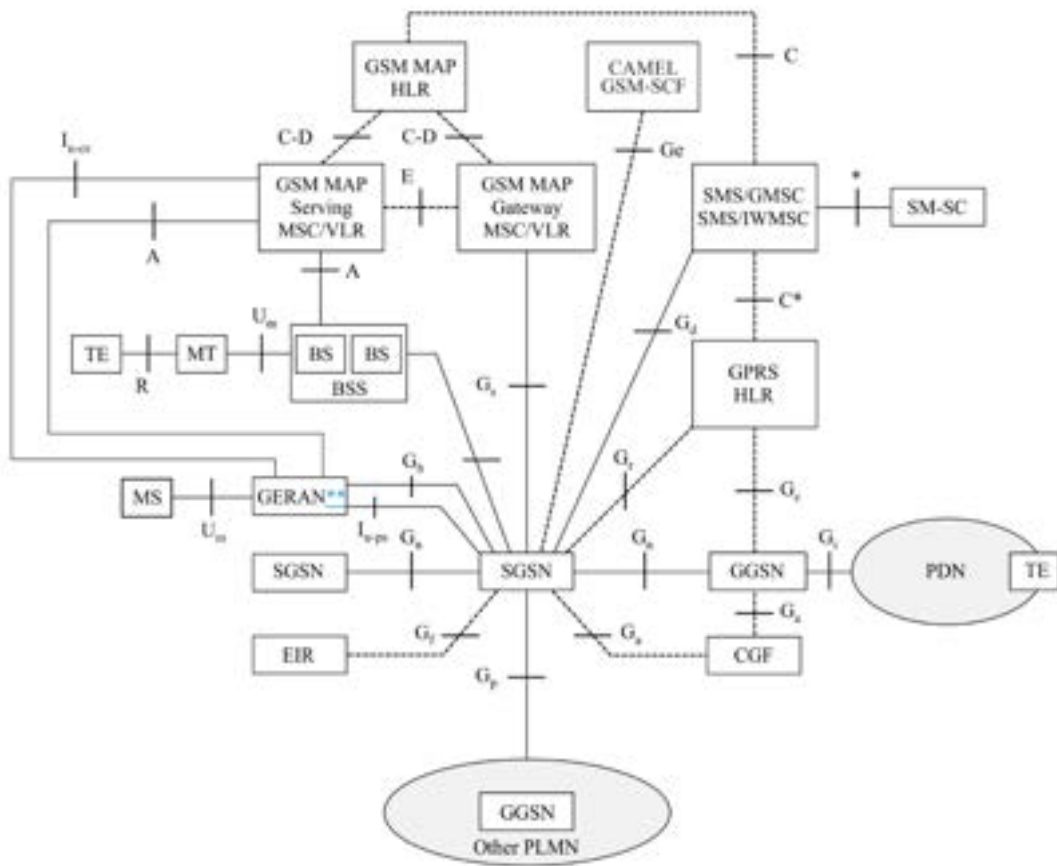

--- Signalling  
 — Signalling and data transfer interface  
 \*\* GERAN in this context is the union of GSM, GPRS, and EDGE

Notes:  
 - For simplicity, not all network elements of TTA/EIA-41 and ETSI GPRS are shown.  
 - Interfaces labeled with \* are implementation specific.  
 - Interface C\* is as defined in ETSI TS 129 002 (35).

<sup>42</sup> For simplicity, not all network elements of this system are shown in Figure 11.

### 3.3.1.1.5 IMT-2000 FDMA/TDMA

The IMT-2000 radio interface specifications for FDMA/TDMA technology are defined by a set of ETSI standards. This radio interface is called digital enhanced cordless telecommunications (DECT). This technology provides a comprehensive set of protocols which provide the flexibility to interwork between numerous different applications and networks. Thus a local and/or public network is not part of this specification. Figure 12 illustrates this.

The radio interface covers, in principle, only the air interface between the fixed part (FP) and portable part (PP). The interworking unit (IWU) between a network and the fixed radio termination (FT) is network specific and is not part of the common interface (CI) specification, but the profile specifications define IWUs for various networks. Similarly, the end system (ES)<sup>43</sup>, the application(s) in a PP is also excluded. The CI specification contains general end-to-end compatibility requirements e.g. on speech transmission. The IWU and ES are also subject to general attachment requirements for the relevant public network, e.g. the PSTN/ISDN.

FIGURE 12

#### The Common Interface structure

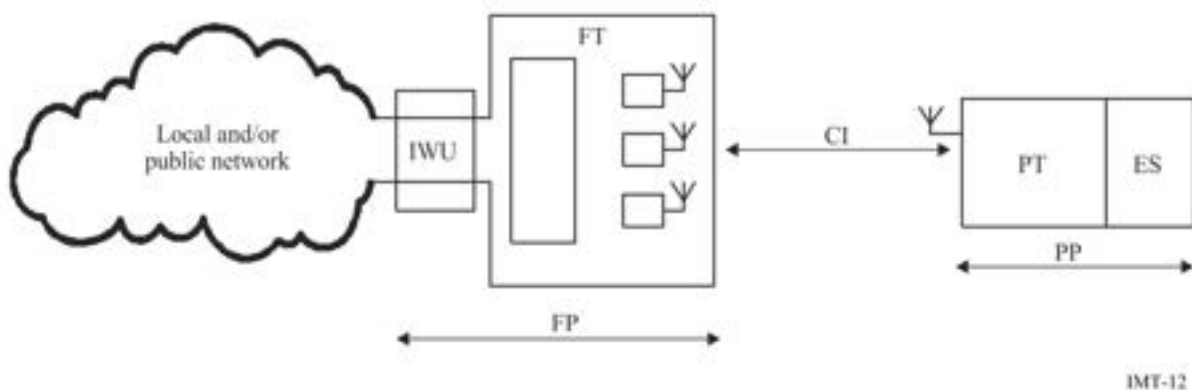

For each specific network, local or global, the specific services and features of that network are made available via the air interface to the users of PPs/handsets. Except for cordless capability and mobility, this standard does not offer a specific service; it is transparent to the services provided by the connected network. Thus the CI standard is, and has to be, a tool box with protocols and messages from which a selection is made to access any specific network, and to provide means for market success for simple residential systems as well as for much more complex systems, e.g. office ISDN services.

IMT-2000 FDMA/TDMA is very suitable to be used as radio access system to connect to mobile networks. Specifically the access to GSM/UMTS networks has been specified in detail, which allows the provision of GSM/UMTS services via DECT. The multipart TS 101 863 contains the UMTS interworking specification.

<sup>43</sup> An ES depends on the application supported in a PP. For a speech telephony application the ES may be a microphone, speaker, keyboard and display. The ES could equally well be a serial computer port, a fax machine or whatever the application requires.

### 3.3.1.1.6 IMT-2000 OFDMA TDD WMAN

The IEEE standard relevant for IMT-2000 OFDMA TDD WMAN, designated as IEEE Std 802.16, is developed and maintained by the IEEE 802.16 Working Group on Broadband Wireless Access. It is published by the IEEE Standards Association (IEEE-SA) of the Institute of Electrical and Electronics Engineers (IEEE).

The radio interface technology specified in IEEE Standard 802.16 is flexible, for use in a wide variety of applications, operating frequencies, and regulatory environments. IEEE 802.16 includes multiple physical layer specifications, one of which is known as WirelessMAN-OFDMA. OFDMA TDD WMAN is a special case of WirelessMAN-OFDMA specifying a particular interoperable radio interface. The component of OFDMA TDD WMAN defined here operates in TDD mode.

The OFDMA TDD WMAN radio interface is designed to carry packet-based traffic, including IP. It is flexible enough to support a variety of higher-layer network architectures for fixed, nomadic, or fully mobile use, with handover support. It can readily support functionality suitable for generic data as well as time-critical voice and multimedia services, broadcast and multicast services, and mandated regulatory services.

The radio interface standard specifies Layers 1 and 2; the specification of the higher network layers is not included. It offers the advantage of flexibility and openness at the interface between Layers 2 and 3 and it supports a variety of network infrastructures. The radio interface is compatible with the network architectures defined in Recommendation ITU-T Q.1701. In particular, a network architecture design to make optimum use of IEEE Standard 802.16 and the OFDMA TDD WMAN radio interface is described in the “WiMAX End to End Network Systems Architecture Stage 2-3”, available from the WiMAX Forum<sup>44</sup>.

The protocol layering is illustrated in Figure 13. The MAC comprises three sub-layers. The service-specific convergence sub-layer (CS) provides any transformation or mapping of external network data, received through the CS service access point (SAP), into MAC service data units (SDUs) received by the MAC common part sub-layer (CPS) through the MAC SAP. This includes classifying external network SDUs and associating them to the proper MAC service flow identifier (SFID) and connection identifier (CID). It may also include such functions as payload header suppression (PHS). Multiple CS specifications are provided for interfacing with various protocols. The internal format of the CS payload is unique to the CS, and the MAC CPS is not required to understand the format of or parse any information from the CS payload.

---

<sup>44</sup> WiMAX End to End Network Systems Architecture Stage 2-3, available at <http://www.wimaxforum.org/technology/documents/>.

FIGURE 13

## OFDMA TDD WMAN protocol layering, showing service access points (SAPs)

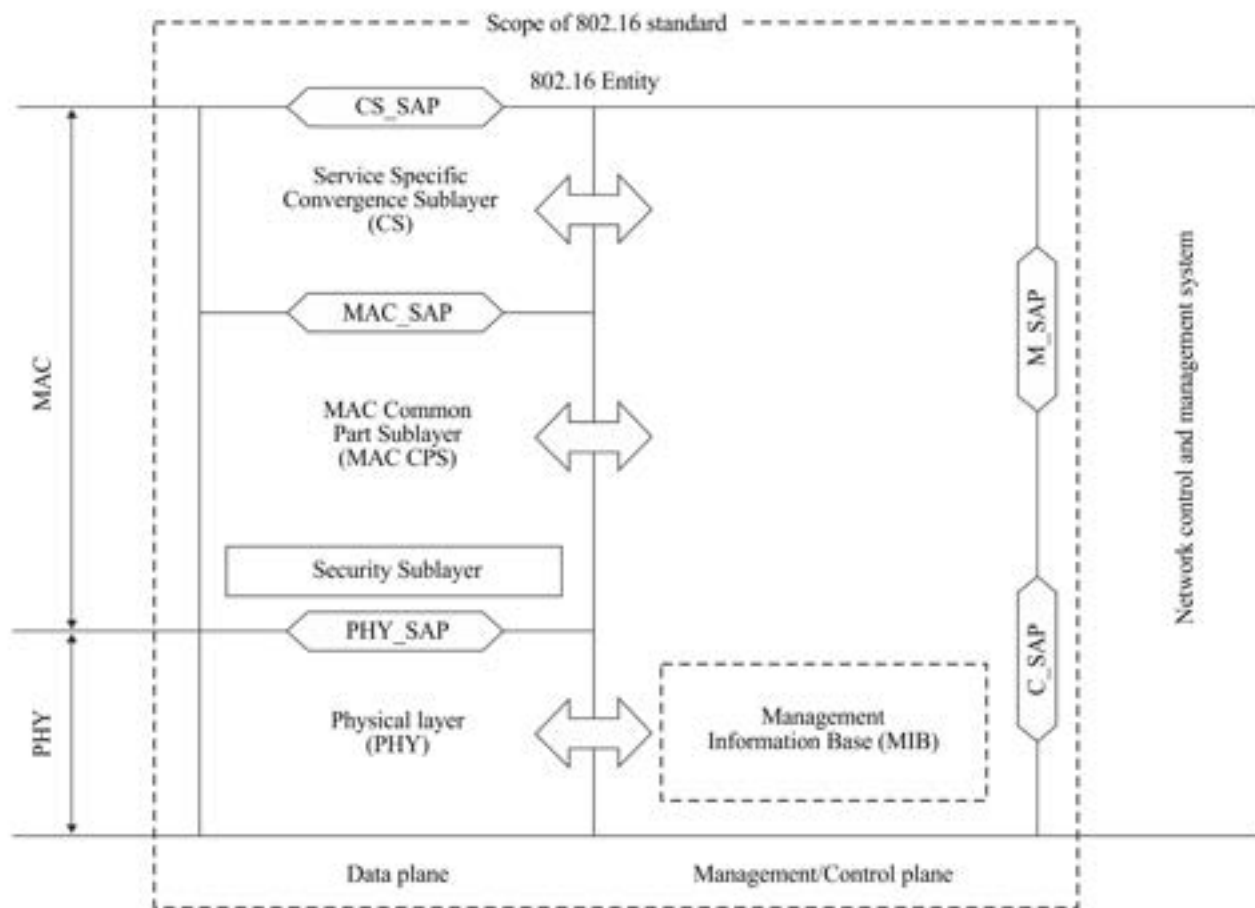

IMT-13

The MAC CPS provides the core MAC functionality of system access, bandwidth allocation, connection establishment, and connection maintenance. It receives data from the various CSs, through the MAC SAP, classified to particular MAC connections.

### 3.3.1.2 IMT-Advanced

#### 3.3.1.2.1 LTE-Advanced

The LTE-Advanced radio-access network has a flat architecture with a single type of node, the eNodeB, which is responsible for all radio-related functions in one or several cells. The eNodeB is connected to the core network by means of the S1 interface, more specifically to the *serving gateway* (S-GW) by means of the user-plane part, S1-u, and to the Mobility Management Entity (MME) by means of the control-plane part, S1-c. One eNodeB can interface to multiple MMEs/S-GWs for the purpose of load sharing and redundancy.

The X2 interface, connecting eNodeBs to each other, is mainly used to support active-mode mobility. This interface may also be used for multi-cell Radio Resource Management (RRM) functions such as Inter-Cell Interference Coordination (ICIC). The X2 interface is also used to support lossless mobility between neighbouring cells by means of packet forwarding.

Inter-cell interference coordination (ICIC), where neighbour cells exchange information aiding the scheduling in order to reduce interference, is supported for the RITs. ICIC can be used for homogenous deployments with non-overlapping cells of similar transmission power, as well as for heterogeneous deployments where a higher-power cell overlays one or several lower-power nodes. The LTE-Advanced Radio-access network interfaces are illustrated in Figure 14.

FIGURE 14

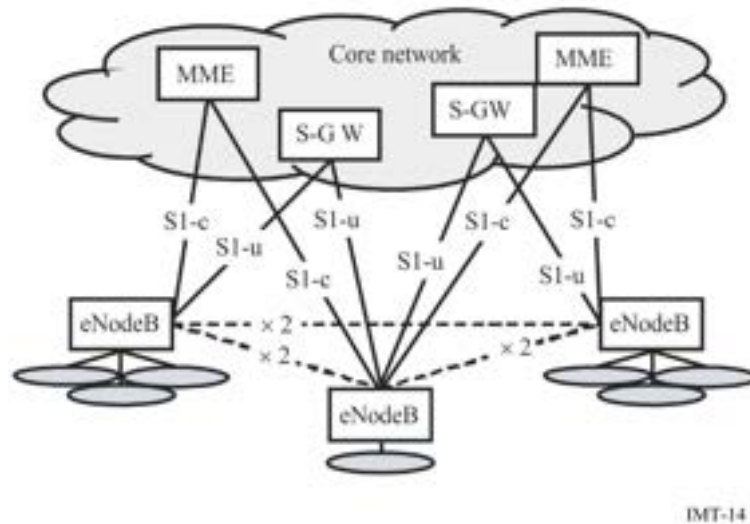
**Radio-access network interfaces****3.3.1.2.2 WirelessMAN-Advanced**

The IEEE standard relevant for WirelessMAN-Advanced, designated as IEEE Std 802.16.1, is developed and maintained by the IEEE 802.16 Working Group on Broadband Wireless Access. It is published by the IEEE Standards Association (IEEE-SA) of the Institute of Electrical and Electronics Engineers (IEEE).

Figure 15 illustrates the protocol layering of IEEE Std 802.16.1-2012. The medium access control (MAC) common part sub-layer (CPS) provides the core MAC functionality of system access, bandwidth allocation, connection establishment, and connection maintenance. It receives data from the various convergence sub-layers (CSs), through the MAC service access point (SAP), classified to particular MAC connections. Quality of service (QoS) is applied to the transmission and scheduling of data over the physical layer (PHY). The MAC also contains a separate security sub-layer providing authentication, secure key exchange, and encryption. Data, PHY control, and statistics are transferred between the MAC CPS and the PHY via the PHY SAP. The MAC comprises three sub-layers. The service-specific CS provides any transformation or mapping of external network data, received through the CS SAP, into MAC service data units (SDUs) received by the MAC CPS through the MAC SAP. This includes classifying external network SDUs and associating them to the proper MAC service flow identifier (SFID) and, for an advanced base station (ABS) or advanced mobile station (AMS), a Station Identifier + Flow Identifier (STID + FID) combination. It may also include such functions as payload header suppression (PHS). Multiple CS specifications are provided for interfacing with various protocols. The internal format of the CS payload is unique to the CS, and the MAC CPS is not required to understand the format of or to parse any information from the CS payload.



FIGURE 15

IEEE 802.16.1 protocol layering, showing service access points (SAPs)

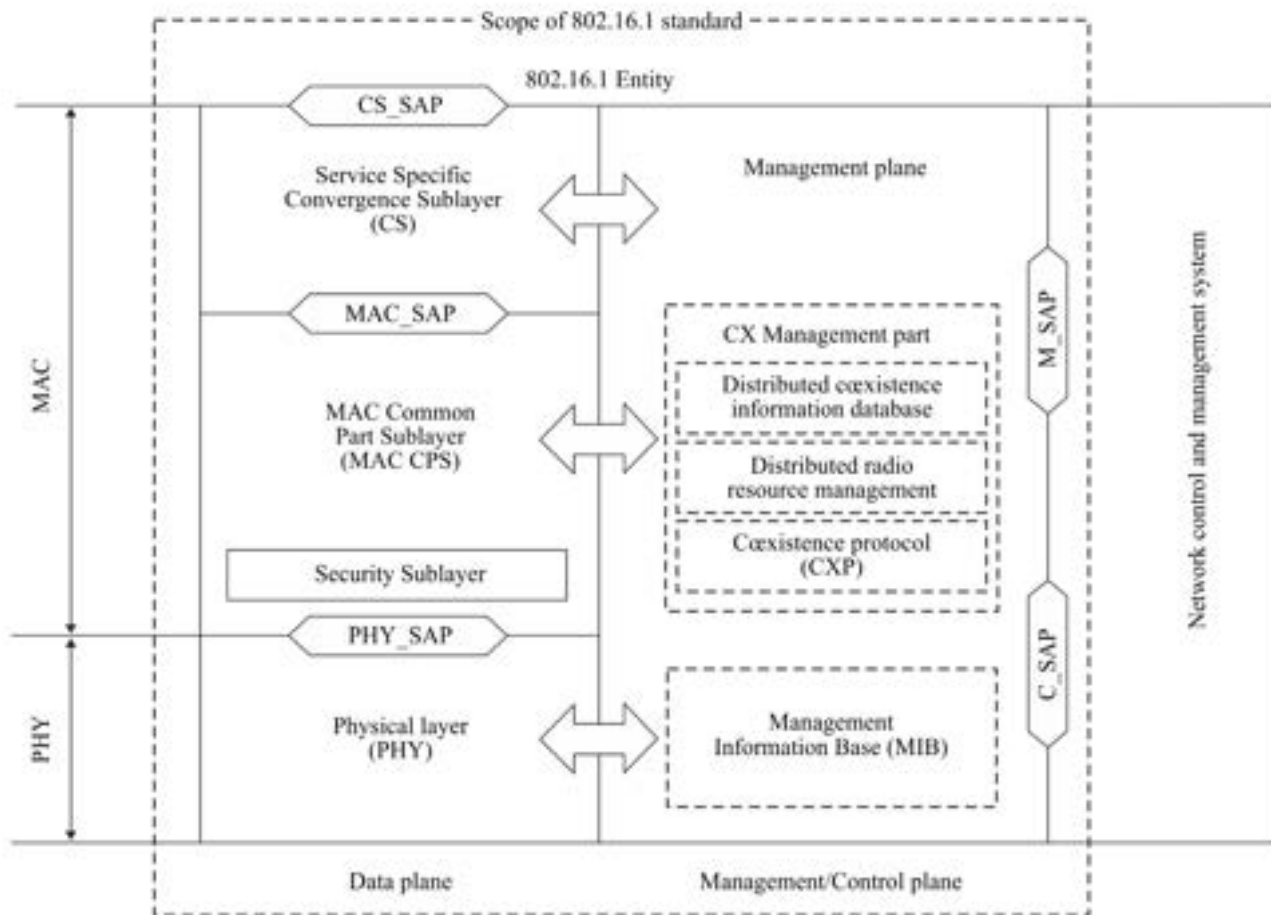

IMT-15

### 3.3.1.3 IMT-2020

#### 3.3.1.3.1 3GPP 5G-SRIT

The IMT-2020 specifications, known as 5G-SRIT, have been developed by 3GPP and consist of long-term evolution (LTE) and new radio (NR) Releases 15 and beyond. In 3GPP terminology, the term Evolved-UMTS Terrestrial Radio Access (E-UTRA) is also used to signify the LTE radio interface.

5G-SRIT is a set of radio interface technologies (RITs) consisting of E-UTRA/LTE as one component RIT and NR as the other component RIT. Both components are designed for operation in IMT spectrum.

The radio-access network of E-UTRA/LTE RIT has a flat architecture with a single type of node, the eNodeB, which is responsible for all radio-related functions in one or several cells. The eNodeB is connected to the core network via the S1 interface, more specifically to the serving gateway (S-GW) by means of the user-plane part, S1-u, and to the Mobility Management Entity (MME) by means of the control-plane part, S1-c. One eNodeB can connect to multiple MMEs/S-GWs for the purpose of load sharing and redundancy. MMEs/S-GWs can be (re)selected for support of separate dedicated core networks that are designed to meet the requirements of a certain group of devices/customers.

The X2 interface, connecting eNodeBs to each other, is mainly used to support active-mode mobility. This interface may also be used for multi-cell Radio Resource Management (RRM) functions such as ICIC or CoMP. The X2 interface is also used to support lossless mobility between neighbouring cells by means of packet forwarding. The architecture is shown in Figure 16.

FIGURE 16

### Radio-access network interfaces

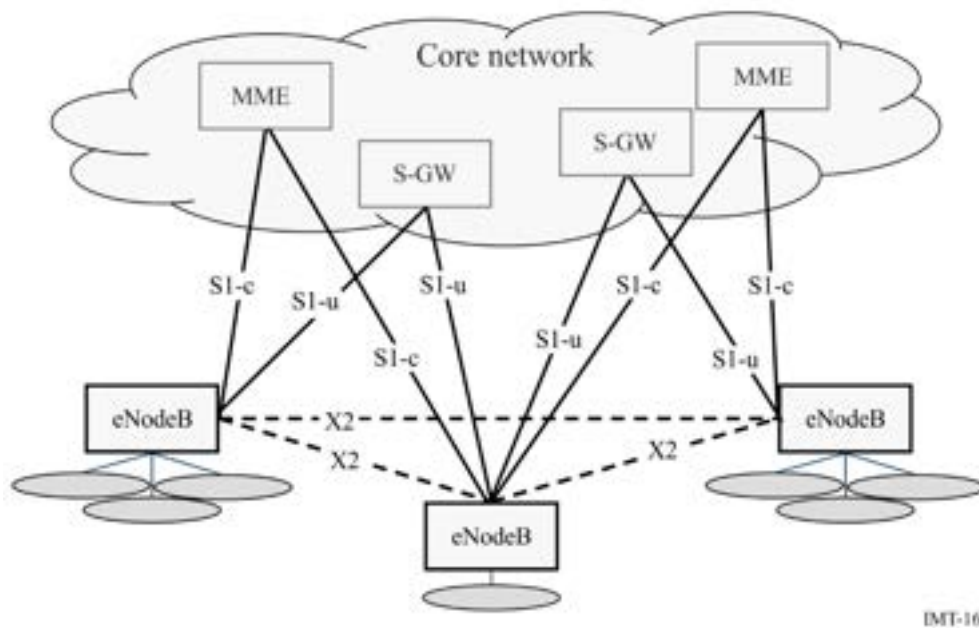

The NR RIT as one component RIT represents the releases 15 and 16 of NR, which uses either 1) FDD operation and therefore is applicable for operation with paired spectrum or 2) TDD operation and therefore is applicable for operation with unpaired spectrum. Channel bandwidths up to 400 MHz and Carrier Aggregation over 16 component carriers are supported, yielding peak data rates up to roughly 140 Gbit/s in the downlink and 65 Gbit/s in the uplink.

An NG-RAN node, is either:

- A gNB, providing NR user plane and control plane protocol terminations towards the UE; or
- An ng-eNB, providing E-UTRA user plane and control plane protocol terminations towards the UE.

NG-RAN nodes are interconnected by means of the interface named Xn. The gNBs and ng-eNBs are also connected by means of the NG interfaces to the 5GC, more specifically to the Access and Mobility Management Function (AMF) by means of the NG-C interface and to the User Plane Function (UPF) by means of the NG-U interface.

The NG-RAN architecture is illustrated in Figure 17.

FIGURE 17

Overall NG-RAN architecture

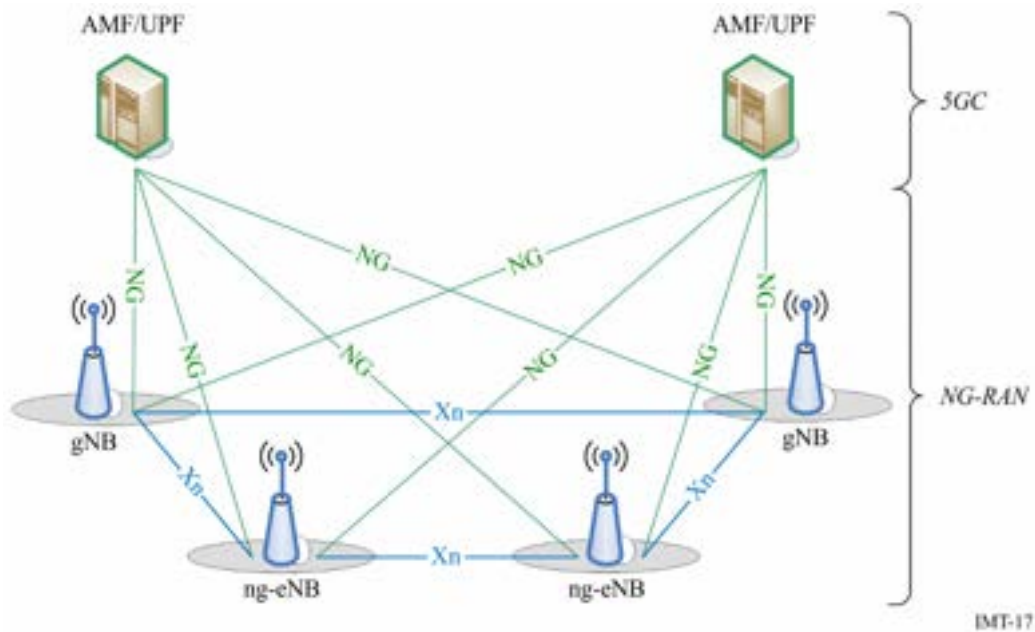

E-UTRAN supports Multi-Radio Dual Connectivity (MR-DC) operation via E-UTRA-NR Dual Connectivity (EN-DC), in which a UE is connected to one eNB that acts as a Master Node (MN) and one en-gNB that acts as a Secondary Node (SN). The eNB is connected to the EPC via the S1 interface and to the en-gNB via the X2 interface. The en-gNB might also be connected to the EPC via the S1-U interface and other en-gNBs via the X2-U interface. NG-RAN supports Multi-Radio Dual Connectivity (MR-DC) operation.

The EN-DC architecture is illustrated in Figure 18.

FIGURE 18

EN-DC overall architecture

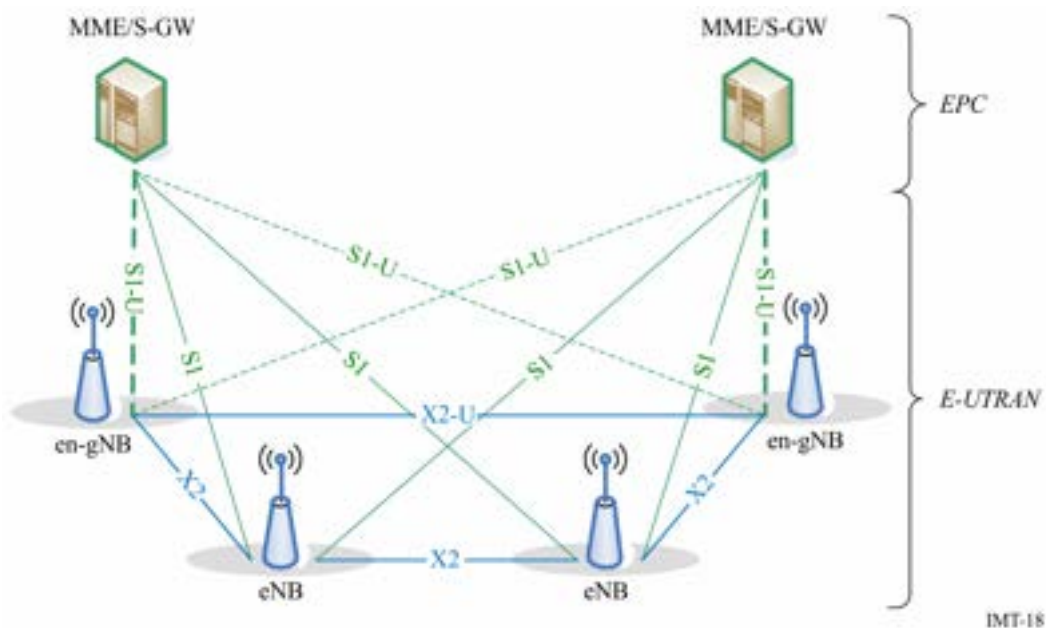

### 3.3.1.3.2 3GPP 5G-RIT

The IMT-2020 specifications known as 5G RIT have been developed by 3GPP and encompass NR Releases 15 and beyond.

The NG Radio Access Network (NG-RAN) includes NG-RAN nodes that support multiple radio access (e.g. NR, MR-DC of NR and E-UTRA, etc). The RIT considers the gNB as an NG-RAN node providing NR user plane and control plane protocol terminations towards the UE and connected via the NG interface to the 5GC, and the ng-eNB as NG-RAN node for Multi-Radio Dual Connectivity only.

NG-RAN nodes are interconnected by means of the interface named Xn. The gNBs and ng-eNBs are also connected by means of the NG interfaces to the 5GC, more specifically to the Access and Mobility Management Function (AMF) by means of the NG-C interface and to the User Plane Function (UPF) by means of the NG-U interface.

The NG-RAN architecture is illustrated in Figure 17 above.

### 3.3.1.3.3 5Gi

TSDSI RIT (5Gi) is a versatile radio interface that fulfils all the technical performance requirements of IMT-2020 across all the different test environments. This RIT focuses on connecting the next generation of devices and providing services across various sectors. This RIT focuses on:

- enhanced spectral efficiency and broadband access;
- low latency communication;
- support millions of IOT devices;
- power efficiency;
- high speed connectivity;
- large coverage (in particular for rural areas);
- support multiple frequency bands including mmWave spectrum.

While, the current specifications provide a robust RIT, the specification also provides a framework on which future enhancements can be supported, providing a future-proof technology.

The overall RAN protocol architecture is shown in Figure 19.

FIGURE 19

#### Control-plane and user-plane protocol stack (AMF is not part of the RAN)

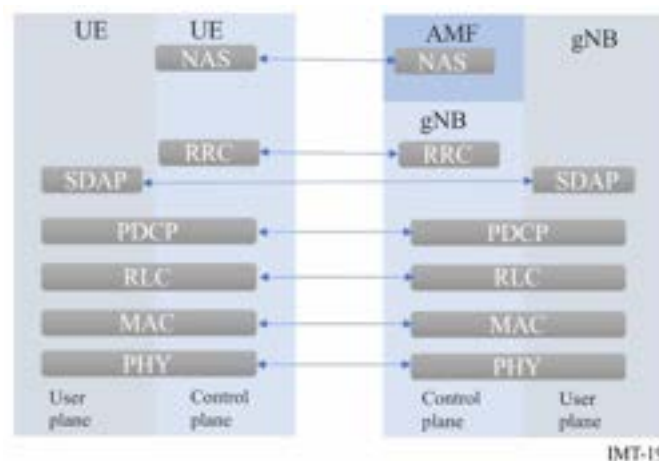

IMT-19

- 1 Physical layer is responsible for coding (decoding), modulation (demodulation), rate adaptation, multi-antenna processing and appropriate waveform generation.

- 2 Medium-Access Control (MAC) layer is responsible for scheduling, hybrid-ARQ and multiplexing of logical channels. Physical layer interacts with MAC using transport channels.
- 3 Radio-link Control (RLC) layer is responsible for packet segmentation and handling retransmissions. MAC layer interfaces with RLC layer using logical channels.
- 4 Packet Data Convergence Protocol (PDCP) layer provides in-sequence delivery of packets, ciphering functionality and integrity protection. RLC interacts with PDCP using RLC channels
- 5 Service Data Application Protocol (SDAP) layer is primarily responsible for managing radio bearers and maintaining QoS requirements.
- 6 Radio Resource Control (RRC) layer is responsible for handling RAN control-plane procedures, transmission of configuration and system parameters.

#### **3.3.1.3.4 DECT 5G-SRIT**

The IMT-2020 specifications have been developed by ETSI TC DECT and 3GPP and consist of DECT-2020 NR Releases 1 and beyond and 3GPP NR Releases 15 and beyond.

The specification is a Set of Radio Interface Technologies (RITs) consisting of DECT-2020 NR as one component RIT and 3GPP NR as the other component RIT. Both components are designed for operation in IMT spectrum.

The SRIT and the component RIT 3GPP NR fulfil all technical performance requirements in all five selected test environments: Indoor Hotspot – enhanced Mobile Broadband (eMBB), Dense Urban – eMBB, Rural – eMBB, Urban Macro – Ultra Reliable Low Latency Communication (URLLC) and Urban Macro – massive Machine Type Communication (mMTC). The component RIT DECT-2020 NR fulfils the technical performance requirements in two selected test environments: Urban Macro – Ultra Reliable Low Latency Communication (URLLC) and Urban Macro – massive Machine Type Communication (mMTC).

Also, the SRIT fulfils the service and the spectrum requirements. Both component RITs, DECT-2020 NR and 3GPP NR, utilize the frequency bands below 6 GHz identified for International Mobile Telecommunication (IMT) in the ITU Radio Regulations. In addition, the 3GPP NR component RIT can also utilize the frequency bands above 6 GHz, i.e. above 24.25 GHz, identified for IMT in the ITU Radio Regulations.

### **3.3.2 IMT Core Network and standards**

#### **3.3.2.1 Recommendation ITU-T Q.1741.8 – IMT-2000 references to Release 10 of GSM-evolved UMTS core network**

This Recommendation identifies the IMT-2000 family member, “GSM evolved UMTS Core Network” corresponding to the “3GPP Release 10”.

The core network interfaces identified in this Recommendation ITU-T Q.1741 and the radio interfaces and radio access interfaces which are identified in Recommendation ITU-R M.1457 constitute a complete system specification for this IMT-2000 family member.

The Recommendation includes 380 items of definition relevant to the network which could be used like a dictionary when readers would like to know compact meaning of any terms.

This Recommendation defines the terms relevant to the core network, of which many are based on definitions given in the references listed in clause 2 of Recommendation ITU-T Q.1741.8.

The core network of 3GPP Release 10 supports IMT-2000 and IMT-Advanced radio access networks as options.

Whereas the basic configuration of a Public Land Mobile Network (PLMN) supporting PS Domain (both GPRS and EPC) and the interconnection to the PSTN/ISDN and PDN is presented in Figure 20. This configuration presents signalling and user traffic interfaces which can be found in a PLMN.

Therefore, all the interfaces within PLMN are external. This Recommendation only describes the internal interfaces in the core network (CN) and the external interfaces to and from CN.

FIGURE 20

**Basic configuration of a 3GPP access PLMN supporting CS and PS services  
(using GPRS and EPS) and interfaces**

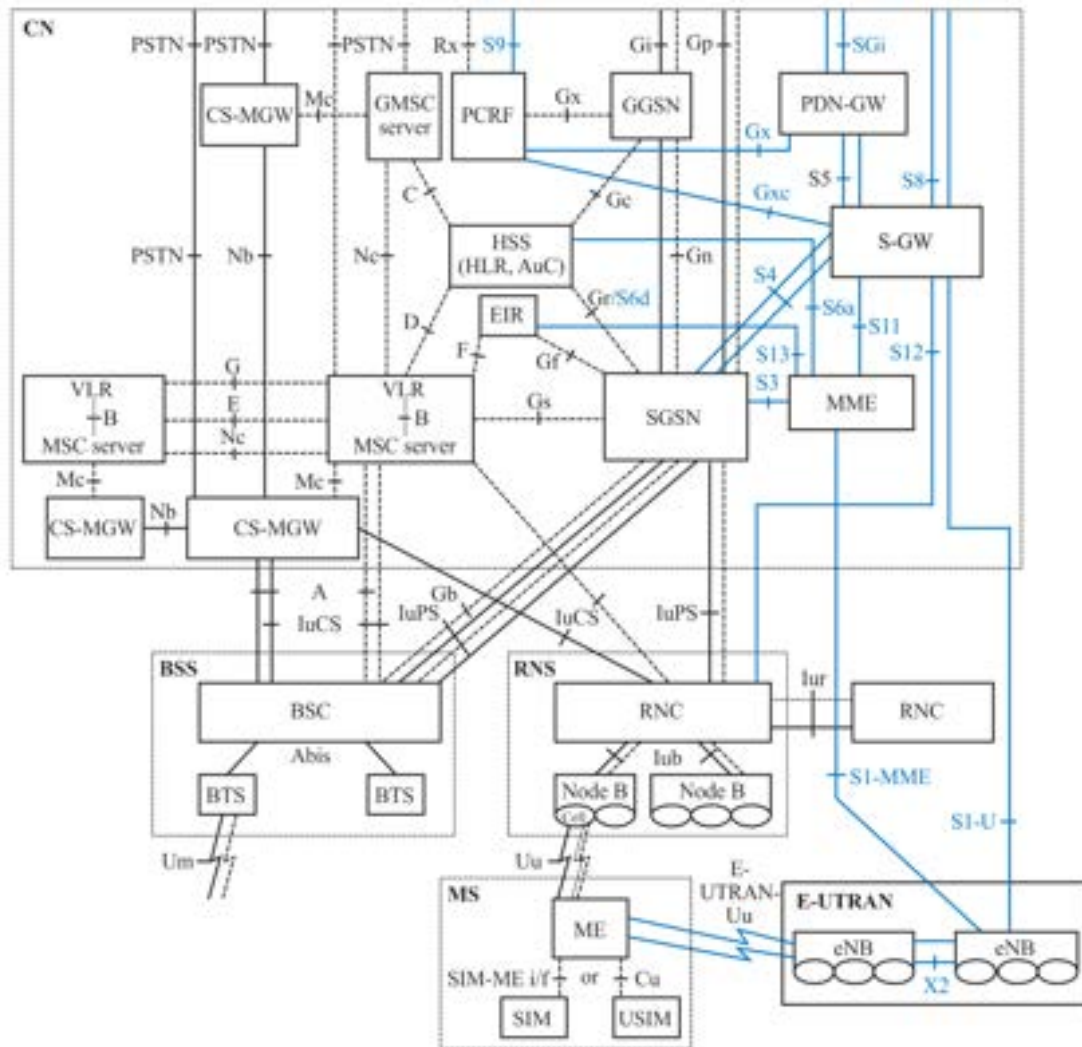

IMT-20

Note to Figure 20: The interfaces in blue represent EPS functions and reference points.

### 3.3.2.2 Recommendation ITU-T Q.1742.11 – IMT 2000 References (3GPP2 up to 31<sup>st</sup> December 2012) to ANSI-41 evolved Core Network with cdma2000 Access Network

This Recommendation identifies the IMT-2000 Family Member; “ANSI-41 evolved Core Network with cdma2000 Access Network.”

The Core Network interfaces identified in this Recommendation and the radio interfaces and radio access network interfaces identified in Recommendation ITU-R M.1457 constitute a complete system specification for this IMT-2000 Family Member.

The Core Network for cdma2000 is based on an evolved ANSI-41 2<sup>nd</sup> generation mobile system. The core network technical specifications have been developed in a third generation partnership project (approved in 3GPP2 as of 31 December 2006) and transposed to the involved regional Standards Development Organizations (SDOs). The system will support different applications ranging from narrow-band to wide-band communications capability with integrated personal and terminal mobility to meet the user and service requirements.

The Recommendation includes 56 items of definition relevant to the network which could be used like a dictionary when readers would like to know compact meaning of any terms.

The basic architecture for the ANSI-41 evolved Core Network with cdma2000 Access Network family member includes a circuit-based and packet based core network and an all-IP multimedia domain.

Figure 21 presents the network entities and associated reference points that comprise the ANSI-41 evolved Core Network with cdma2000 Access Network. The network entities are represented by squares, triangles and rounded corner rectangles; circles represent the reference points. The network reference model in this Recommendation is the compilation of several reference models currently in use.

FIGURE 21

ANSI-41 evolved core network with cdma2000 access network reference model

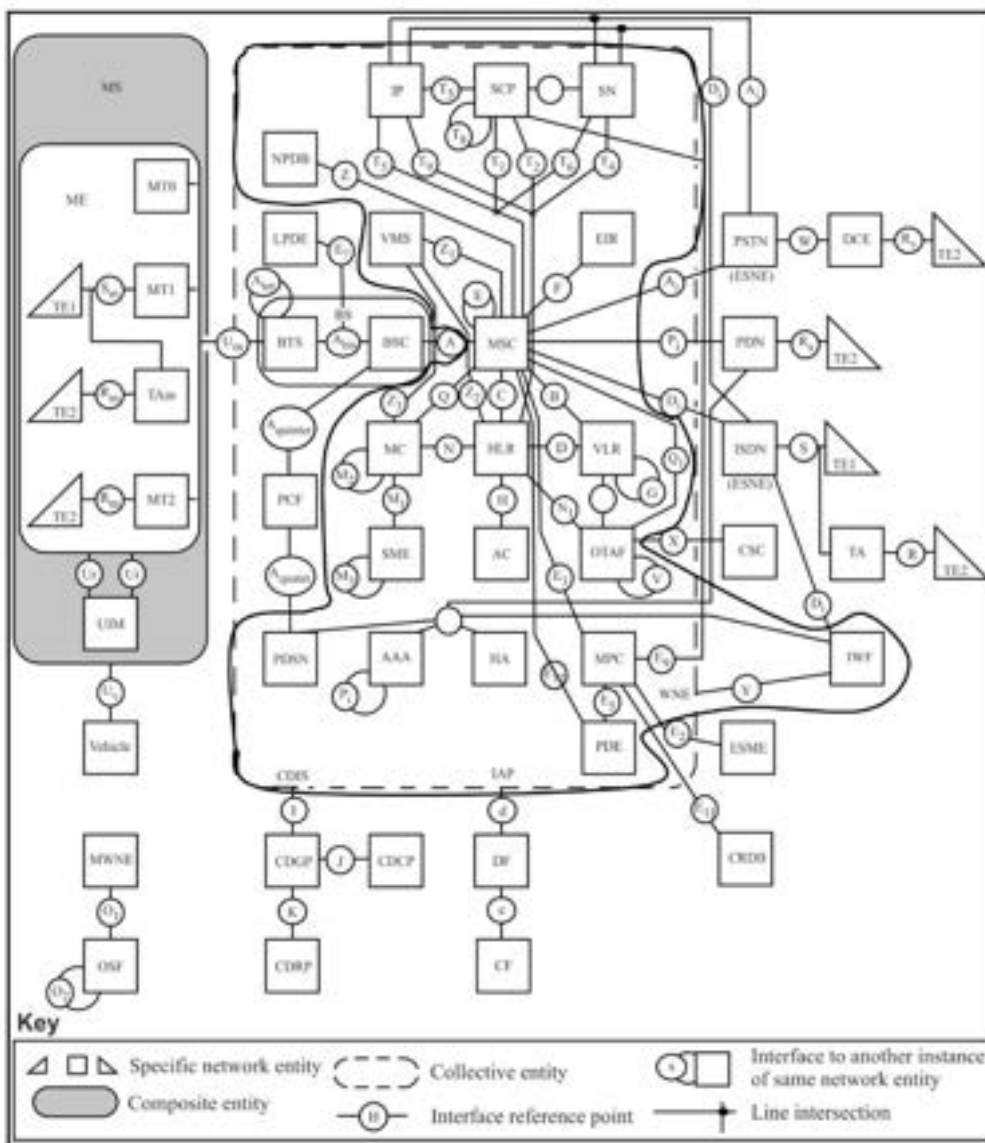

IMT-21

Note to Figure 21: The portion of the Figure within the solid line is the Core Network.



<b>AAA</b>	Authentication, Authorization and Accounting	<b>MC</b>	Message Centre
<b>AC</b>	Authentication Centre	<b>ME</b>	Mobile Equipment
<b>BS</b>	Base Station	<b>MPC</b>	Mobile Position Centre
<b>BSC</b>	Base Station Controller	<b>MS</b>	Mobile Station
<b>BTS</b>	Base Transceiver System	<b>MSC</b>	Mobile Switching Centre
<b>CDCP</b>	Call Data Collection Point	<b>MT</b>	Mobile Terminal
<b>CDGP</b>	Call Data Generation Point	<b>MWNE</b>	Managed Wireless Network Entity
<b>CDIS</b>	Call Data Information Source	<b>NPDB</b>	Number Portability DataBase
<b>CDRP</b>	Call Data Rating Point	<b>OSF</b>	Operations System Function
<b>CF</b>	Collection Function	<b>OTAF</b>	Over-The-Air Service Provisioning Function
<b>CRDB</b>	Coordinate Routing Data Base	<b>PCF</b>	Packet Control Function
<b>CSC</b>	Customer Service Centre	<b>PDE</b>	Position Determining Entity
<b>DCE</b>	Data Circuit Equipment	<b>PDN</b>	Packet Data Network
<b>DF</b>	Delivery Function	<b>PDSN</b>	Packet Data Serving Node
<b>EIR</b>	Equipment Identity Register	<b>PSTN</b>	Public Switched Telephone Network
<b>ESME</b>	Emergency Services Message Entity	<b>SCP</b>	Service Control Point
<b>ESNE</b>	Emergency Services Network Entity	<b>SN</b>	Service Node
<b>HA</b>	Home Agent	<b>SME</b>	Short Message Entity
<b>HLR</b>	Home Location Register	<b>TA</b>	Terminal Adapter
<b>IAP</b>	Intercept Access Point	<b>TE</b>	Terminal Equipment
<b>IIF</b>	Interworking and Interoperability Function	<b>UIM</b>	User Identity Module
<b>IP</b>	Intelligent Peripheral	<b>VLR</b>	Visitor Location Register
<b>ISDN</b>	Integrated Services Digital Network	<b>VMS</b>	Voice Message System
<b>IWF</b>	Interworking Function	<b>WNE</b>	Wireless Network Entity
<b>LPDE</b>	Local Position Determining Entity	<b>WPSC</b>	Wireless Priority Service Centre
<b>LNS</b>	L2TP Network Server		

In the Recommendation, the following Core Network Architecture Model are also explained other than the above reference model:

- IP MMD (Multimedia Domain)
- Packet Data Subsystem (PDS)
- IP Multimedia Session (IMS) Subsystem

### 3.3.3 Collaboration and process in the development of IMT radio interface specifications

IMT is a system with global development activity and the IMT radio interface specifications identified in Recommendations ITU-R M.1457 for IMT-2000, ITU-R M.2012 for IMT-Advanced and ITU-R M.2150 for IMT-2020, have been developed by the ITU in collaboration with the radio interface technology proponent organizations, global partnership projects and SDOs, and subsequently approved by the ITU Member States.



ITU-R has provided the global and overall framework and requirements, and has developed the core global specifications jointly with these organizations which are documented in Recommendations ITU-R M.1457, M.2012 and M.2150. Thus the detailed standardization has been undertaken within the recognized external organization<sup>45</sup>, who transpose the global core specifications contained in those Recommendations into their own detailed published standards ensuring the global applicability and commonality of IMT. Annex E contains descriptions of external organizations that have contributed to the development of IMT and Annex F contains a list of published Recommendations, Reports and ongoing activities of ITU-R on the terrestrial component of IMT.

This joint standardization approach is guided by Resolution ITU-R 9 – Liaison and collaboration with other relevant organizations, in particular ISO and IEC, and Resolution ITU-R 57 – Principles for the process of development of IMT Advanced.

Resolution ITU-R 57 has been the foundation for the creation of a set of well-defined procedures<sup>46</sup> in ITU-R to address the process and activities identified for the development of the IMT terrestrial components radio interface Recommendations<sup>47</sup>. This set of procedures includes announcement of a call for proposals for new radio interfaces and for updates to existing radio interfaces, the preparation of ITU-R Recommendations and Reports that define the minimum requirements for terrestrial IMT, the submission process, the evaluation process, and the development of the detailed radio interface specifications themselves. Detailed timelines are produced for each stage of the process.

Such an approach has led to effective and efficient collaboration with the relevant external organizations engaged in IMT and contributes positively to the planning, organization, and management of the work both in ITU-R and in the external organizations resulting in timely and on-going enhancements to IMT. This successful mechanism is already being utilized for the future development of IMT beyond that of IMT-2020 in activities currently underway in ITU-R<sup>48</sup>.

### 3.4 Techniques to facilitate roaming

Roaming is facilitated by:

- 1) using the frequency bands identified for IMT in the Radio Regulations (RR);
- 2) following the frequency arrangements in Recommendation ITU-R M.1036 – Frequency arrangements for implementation of the Terrestrial component of International Mobile Telecommunications (IMT) in the bands identified for IMT in the Radio Regulations (RR), (03/2012), which provides guidance on the selection of transmitting and receiving frequency arrangements for the terrestrial component of IMT;

---

<sup>45</sup> A “recognized organization” in this context is defined to be a recognized SDO that has legal capacity, a permanent secretariat, a designated representative, and open, fair, and well-documented working methods.

<sup>46</sup> Web pages in ITU-R have been established to document the process for IMT-2000 submission and evaluation, the process for IMT-Advanced submission and evaluation and the process for IMT-2020 submission and evaluation associated with developing and/or revising the relevant ITU-R Recommendations for the terrestrial components of the IMT radio interfaces.

<sup>47</sup> The procedures defined in the “IMT-ADV” series of documents for IMT-Advanced in conjunction with Resolution ITU-R 57 have recently be applied to the on-going enhancement of IMT-2000 from year 2013 onwards as defined in the “IMT-2000” series of documents. The adoption of a common set of procedures for IMT-2000 and IMT-Advanced further improves and streamlines the work management both in ITU-R and in the relevant external organizations on IMT development.

<sup>48</sup> See “ITU towards IMT for 2020 and beyond” and the ITU article “Beyond 5G: What’s next for IMT?”.

- 3) using the 3GPP operating band that are defined in Table 5.5-1 in the 3GPP TS 36.101 [http://www.3gpp.org/ftp/Specs/archive/36\\_series/36.101/36101-c60.zip](http://www.3gpp.org/ftp/Specs/archive/36_series/36.101/36101-c60.zip)<sup>49</sup>, in Table 5.0 in the 3GPP TS 25.101 [http://www.3gpp.org/ftp/Specs/archive/25\\_series/25.101/25101-c60.zip](http://www.3gpp.org/ftp/Specs/archive/25_series/25.101/25101-c60.zip)<sup>50</sup> and section 5.2 in the Technical Specification 3GPP TS 25.102 [http://www.3gpp.org/ftp/Specs/archive/25\\_series/25.102/25102-c00.zip](http://www.3gpp.org/ftp/Specs/archive/25_series/25.102/25102-c00.zip)<sup>51, 52</sup>; and
- 4) using the 3GPP2 operating band defined in Table 1.5-1 in the band class specification 3GPP2 C.S0057 [http://www.3gpp2.org/public\\_html/specs/C.S0057-E\\_v1.0\\_Bandclass Specification.pdf](http://www.3gpp2.org/public_html/specs/C.S0057-E_v1.0_Bandclass Specification.pdf)<sup>53, 54</sup>.

It should be noted that the technology used by a system and its conformance with the recommended specifications and standards in Recommendation ITU-R M.1457 define that system as IMT-2000, and Recommendation ITU-R M.2012 define that system as IMT-Advanced regardless of the frequency band of operation as explained in *considering k*) of Recommendation ITU-R M.1580. So it should be also noted that harmonized frequency arrangements for the bands identified for IMT are addressed in Recommendation ITU-R M.1036, which also indicates that some administrations may deploy IMT-2000 systems in bands other than those identified to IMT in the RR, as explained in *considering l*) of the same Recommendation mentioned above.

## 4 IMT spectrum

### 4.1 International spectrum identified for IMT

A number of frequency bands are identified for IMT in the Radio Regulations (RR). Recommendation ITU-R M.1036 provides guidance on the selection of transmitting and receiving frequency arrangements for the terrestrial component of IMT systems with a view to assisting administrations on spectrum-related technical issues relevant to the implementation and use of the terrestrial component of IMT in the bands identified in the Radio Regulations.

The following bands are identified for IMT in the Radio Regulations (RR) Edition 2020, as shown in Table 1. This identification does not preclude the use of these bands by any application of the services to which they are allocated or identified and does not establish priority in the Radio Regulations. It has to be noted that different regulatory provisions apply to each band. The Regional deviations for each band are described in the different footnotes applying in each band, as shown in Table 1.

---

<sup>49</sup> 3GPP TS 36.101 V12.6.0 (2014-12): “Evolved Universal Terrestrial Radio Access (E-UTRA); User Equipment (UE) radio transmission and reception” (Table 5.5-1).

<sup>50</sup> 3GPP TS 25.101 V12.6.0 (2014-12): “Technical Specification Group Radio Access Network; User Equipment (UE) radio transmission and reception (FDD)” (Table 5.0).

<sup>51</sup> 3GPP TS 25.102 V12.0.0 (2014-09): “Technical Specification Group Radio Access Network; User Equipment (UE) radio transmission and reception (TDD)” (Section 5.2).

<sup>52</sup> It should be noted that some bands standardized in 3GPP are not identified for IMT, and are not part of the Harmonized frequency arrangements of Recommendation ITU-R M.1036.

<sup>53</sup> 3GPP2 C.S0057-E Version 1.0 October 2010: “Band Class Specification for cdma2000 Spread Spectrum Systems Revision E.

<sup>54</sup> It should be noted that some bands standardized in 3GPP2 are not identified for IMT, and are not part of the Harmonized frequency arrangements of Recommendation ITU-R M.1036.

TABLE 1

Band	Footnotes identifying the band for IMT		
	Region 1	Region 2	Region 3
450-470 MHz	5.286AA		
470-698 MHz	–	5.295, 5.308A	5.296A
694/698-960 MHz	5.317A	5.317A	5.313A, 5.317A
1 427-1 518 MHz	5.341A, 5.346	5.341B	5.341C, 5.346A
1 710-2 025 MHz	5.384A, 5.388		
2 110-2 200 MHz	5.388		
2 300-2 400 MHz	5.384A		
2 500-2 690 MHz	5.384A		
3 300-3 400 MHz	5.429B	5.429D	5.429F
3 400-3 600 MHz	5.430A	5.431B	5.432A, 5.432B, 5.433A
3 600-3 700 MHz	–	5.434	–
4 800-4 990 MHz	5.441B	5.441A, 5.441B	5.441B
24.25-27.5 GHz	5.532AB		
37-43.5 GHz	5.550B		
45.5-47 GHz	5.553A	5.553A	5.553A
47.2-48.2 GHz	5.553B	5.553B	5.553B
66-71 GHz	5.559AA		

Also, administrations may deploy IMT systems in bands other than those identified in the RR, and administrations may deploy IMT systems only in some or parts of the bands identified for IMT in the RR.

However, it is emphasized that the use of IMT in any band allocated to the mobile service on a primary basis but not identified for IMT should also comply with the objectives of the relevant technical and regulatory provisions of the RR, as well as with the latest version of applicable ITU-R Recommendation(s).

## 4.2 Frequency arrangements

The frequency arrangements for IMT contained in Recommendation ITU-R M.1036 are provided with the intent of enabling the most effective and efficient use of the spectrum to deliver IMT services – while minimizing the impact on other systems or services in these bands – and facilitating the growth of IMT systems.

The recommended frequency arrangements together with implementation aspects for IMT in the bands identified in the RR are provided in the latest revision of Recommendation ITU-R M.1036 – Frequency arrangements for implementation of the terrestrial component of International Mobile Telecommunications (IMT) in the bands identified for IMT in the Radio Regulations (RR). This Recommendation is updated after each WRC where new frequencies are identified for IMT. At the time of completion of this handbook the Recommendation in force does not include yet frequency arrangements for the bands identified for IMT in the range 24.25 GHz to 71 GHz; however, it is envisaged that only TDD arrangements are recommended in these bands.

## 4.3 Methods to Estimate spectrum requirements for IMT

The methodology to estimate spectrum requirements for IMT is described in Recommendation ITU-R M.1768-1 – Methodology for calculation of spectrum requirements for the terrestrial component of IMT. Report ITU-R M.2290 – Future spectrum requirements estimate for terrestrial IMT, provides a global perspective on the future spectrum requirement estimated for terrestrial IMT. The input parameters in this Report are not country specific. In some countries, the spectrum requirements can be lower than the low estimate and in some other countries, the spectrum requirements can be higher than the high estimate (see Annex 4 of Report ITU-R M.2290, Summary of national spectrum requirements in some countries). The methodology explained in the Recommendation and utilised in the Report could be used to estimate the total IMT spectrum requirements of a given country only if all the current input parameter values used in this report are replaced by the values which apply to that specific country (as described in the methodology itself).

There is a user guide on the methodology as “User guide for the IMT spectrum requirement estimation tool” in the ITU-R WP5D web-page whose address is <http://www.itu.int/en/ITU-R/study-groups/rsg5/rwp5d/Pages/default.aspx>. As described in the guide, the methodology of estimating the spectrum requirements for IMT is implemented in MS Excel as a Spectrum Calculator tool to facilitate its use. The tool is also available under the “reference” of the ITU-R WP 5D web-page for users with TIES (Telecommunication Information Exchange Service) accounts.

The tool consists of 27 worksheets and seven modules of macros. The worksheets present input parameter values, intermediate calculation results obtained from worksheet calculations and macro calculations, and the final spectrum requirements. The tool is executed from its opening sheet called “Main”, which is the core of the tool.

Figure 22 hereunder shows the relationship between the methodology flow chart and the corresponding worksheets in the “Spectrum Calculator” tool as well as the different input parameters to the methodology calculation steps. The worksheets with a grey background colour in Figure 22 denote the locations in the tool where the input parameter values are inserted. The worksheets with a white background colour in Figure 22 are where the actual calculation is implemented including intermediate calculation results. For further information please refer to the user guide.

FIGURE 22

**Input parameters, methodology flow chart and corresponding worksheets in the ‘Spectrum Calculator’ tool**

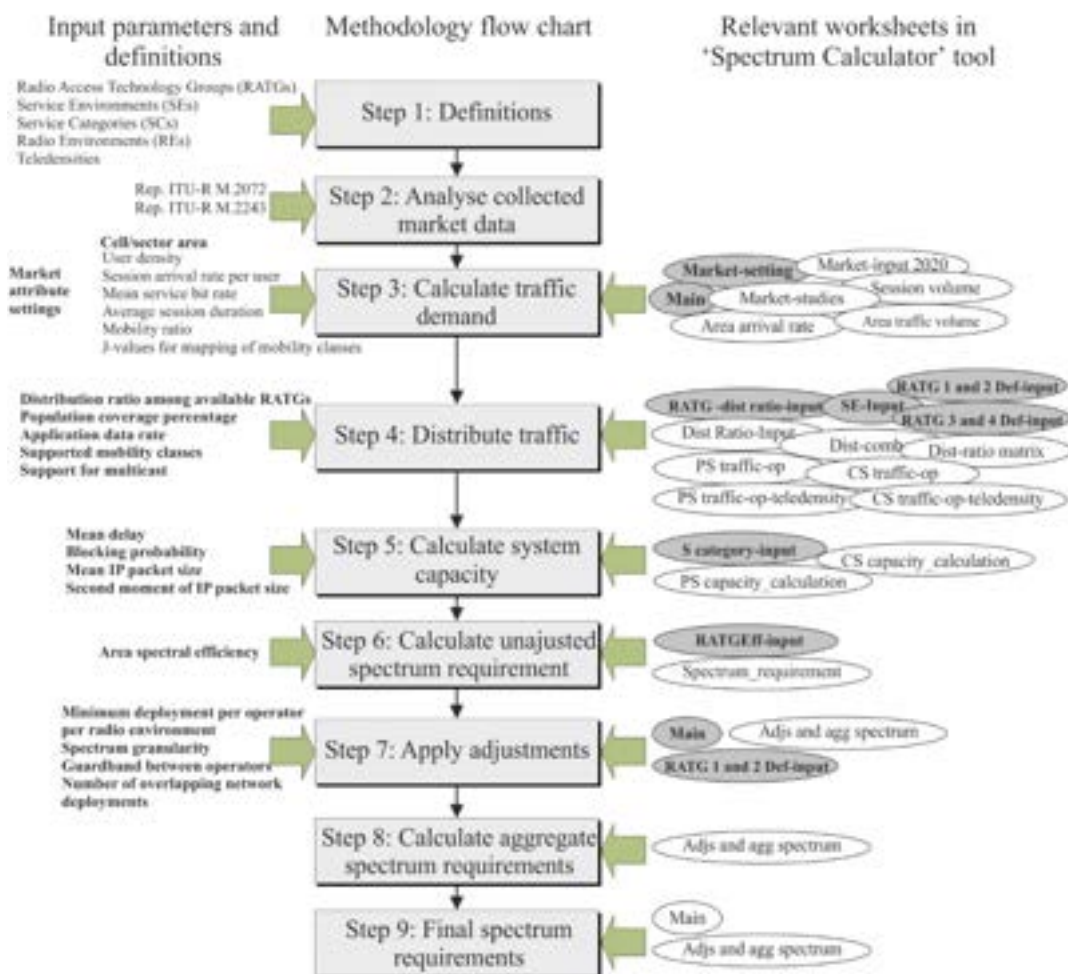

## **5 Regulatory issues**

### **5.1 Institutional aspects and arrangements**

To facilitate the successful deployment of IMT systems, the policy to make the spectrum available to the market should be clearly stated. In order to guarantee that the spectrum policy is aligned with the country's main objectives, it is important that telecommunications should figure on country's main agenda. In this way, regulators and other government institutions will have the necessary support to conduct their activities.

Another important aspect that can foster IMT deployment is related to the institution arrangements for policy delivery. The agency responsible for the spectrum policy should pay close attention to the role of each government agent (national and subnational) as well as other market stakeholders. It is also important to avoid responsibility overlap or gaps in order to facilitate the achievement of goals, diminish tension between institutions, and encourage agreements.

In addition, all stakeholders should have a clear understanding of the decision-making process. This could be accomplished through the development of a code of practice for the decision-making process, enabling both regulators and operators to have a clear understanding of how regulatory decisions are made, and any applicable processes for appealing such decisions.

### **5.2 Transparency and stakeholder involvement**

In order to ensure that regulatory and policy decisions are made in the best interest of all, an open and public decision-making process should be used. This has two main benefits. First, by using a process that provides for public review and comment of proposed regulations and decisions, policymakers and regulators ensure that the regulatory and policy regime is not developed in a vacuum, and that current and expected future mobile market developments are considered. Policymakers, operators and vendors each have unique insights on the mobile market that, when considered together, have the best chance of developing a mobile sector based on international best practices and up-to-date market and technology intelligence.

Second, an open and public policy development process will lead to greater transparency, a key characteristic of any good decision-making process. By soliciting input from stakeholders and the public at large, and ensuring that industry plays a central role in the development of policies and priorities, regulators have an increased likelihood of crafting a regulatory and policy regime that is supported by most, if not all, interested parties. There are various approaches to including private sector stakeholders in the regulatory process, including standing advisory panels or groups, public consultations, and targeted solicitation of inputs, none of which are mutually exclusive. The close cooperation of regulators and industry is crucial to the development of a robust regulatory regime as well as a successful mobile industry.

### **5.3 Market knowledge**

In order to develop good IMT spectrum policy, it is important for regulators and government institutions to know the actual market status and the community needs. To know the needs, the governments can conduct surveys, collect data through public consultations, and other feedback instruments that enable the market and the society to show their opinions and needs. This process can enhance government's decision making process, improving the effectiveness and quality of the public policies.

Besides, government agencies may also take into account cultural aspects, social conditions, and demographical disparities, since these aspects may influence the development of spectrum policy instruments.

### **5.4 Spectrum licensing**

#### **5.4.1 IMT licensing considerations**

Many considerations may impact IMT licensing conditions including the following:

- Technology requirements
- Coverage/roll-out obligations
- Timing of license assignments

- Duration of licenses
- Spectrum block size
- Number of operators
- Infrastructure sharing
- Number portability.

#### **5.4.2 IMT licensing principles and methods**

Many methods of assigning spectrum licenses exist. These methods follow two approaches: 1) non-market based assignments such as comparative process (also known as beauty contests) and lotteries 2) market-based approaches such as auctions. In cases of limited demand for a particular frequency band in a particular geographic area, first-come first served licensing may also be considered. Licensing is a national prerogative and each country must decide what methodology is appropriate for the conditions that exist within its legal, regulatory, and market framework.

To the maximum practical extent, spectrum should be licensed in alignment with regionally and internationally harmonized mobile spectrum bands to enable economies of scale, reduce cross-border interference and facilitate international services. Also, licensing authorities should publish roadmaps of the planned release of additional spectrum bands to maximize the benefits of spectrum use. A spectrum roadmap should take a long-term and holistic approach and include a comprehensive and reasonably detailed inventory of current use.

Furthermore, transferable and flexible spectrum rights may also be considered when assigning spectrum licenses. According to Report ITU-R SM.2012, "... economists recommend that spectrum users be allowed to transfer their spectrum rights (whether assigned by auction or some other assignment mechanism) and that spectrum users have a high degree of flexibility in the choice of the consumer services that they provide with their spectrum."

For more information on spectrum assignment methods, see section 2.3.1 of Report ITU-R SM.2012.

#### **5.5 IMT spectrum clearing (including re-farming) guidelines**

Recommendation ITU-R SM.1603-1 – Spectrum redeployment as a method of national spectrum management, gives guidelines for spectrum redeployment issues. This Recommendation defines spectrum redeployment (also known as spectrum re-farming) as "a combination of administrative, financial and technical measures aimed at removing users or equipment of the existing frequency assignments either completely or partially from a particular frequency band. The frequency band may then be allocated to the same or different service(s). These measures may be implemented in short, medium or long time-scales." The Recommendation also provides a guide for national consideration of redeployment issues.

#### **5.6 Global circulation of terminals**

The global circulation of terminals allows users to carry their personal terminals into a visited country and the ability to use them wherever possible. Recommendation ITU-R M.1579 establishes the technical basis for global circulation of IMT 2000 terrestrial terminals, based on terminals not causing harmful interference in any country where they circulate. Further information can be found in Recommendation ITU-R M.1579 – Global circulation of IMT-2000 terrestrial terminals.

#### **5.7 Unwanted emissions**

Information regarding unwanted emissions can be found in Recommendation ITU-R M.1580 – Generic unwanted emission characteristics of base stations using the terrestrial radio interfaces of IMT-2000, and Recommendation ITU-R M.1581 – Generic unwanted emission characteristics of mobile stations using the terrestrial radio interfaces of IMT-2000. In addition, information on IMT-Advanced can be found in Recommendation ITU-R M.2070 – Generic unwanted emission characteristics of base stations using the terrestrial radio interfaces of IMT-Advanced, and Recommendation ITU-R M.2071 – Generic unwanted emission characteristics of mobile stations using the terrestrial radio interfaces of IMT-Advanced.

## **6 Steps to consider in the deployment of IMT systems**

### **6.1 Key issues and questions to be considered prior to IMT network deployment**

Key issues to be considered are as follows:

- Spectrum Harmonization
- Maturity of the technology to be introduced
- Device availability and affordability
- Market evolution directions
- Radio Interface standards referring to ITU-R Recommendations and Reports
- Demographics and services (e.g. support of new services and applications)
- Time frame for transition
- Assistance to customer in changeover to new technology
- Compatibility with incumbent telecommunication systems.

### **6.2 Migration of existing wireless systems to IMT**

#### **6.2.1 Migration strategy**

There are some issues to be considered when planning the migration from GSM to IMT. These issues are as follows:

- Amount of existing wireless system (e.g. GSM) spectrum available
- Traffic balance between low band (e.g. GSM 850/900 MHz) and high band (e.g. GSM – 1 800/1 900 MHz)
- Solutions to increase GSM's network capacity: Voice services over Adaptive Multi-user channels on One Slot (VAMOS), Orthogonal Sub-channels (OSC), tight frequency reuse, etc.
- Voice traffic migration to IMT (e.g. UMTS/LTE)
- Re-farming technology decisions (e.g. Introduction of HSPA/LTE to GSM 850/900 MHz and GSM 1 800/1 900 MHz)
- Re-farming roadmap (e.g. gradual introduction of IMT to GSM bands or re-farming of both GSM 850/900 MHz and GSM 1 800/1 900 MHz at the same time).

#### **6.2.2 General migration process**

The Spectrum migration consists of a solution which reduces the spectrum needed to a desired limit without compromising on performance of the existing network, which can be structured in five phases and activities as outlined below and summarized in Figure 23.

FIGURE 23

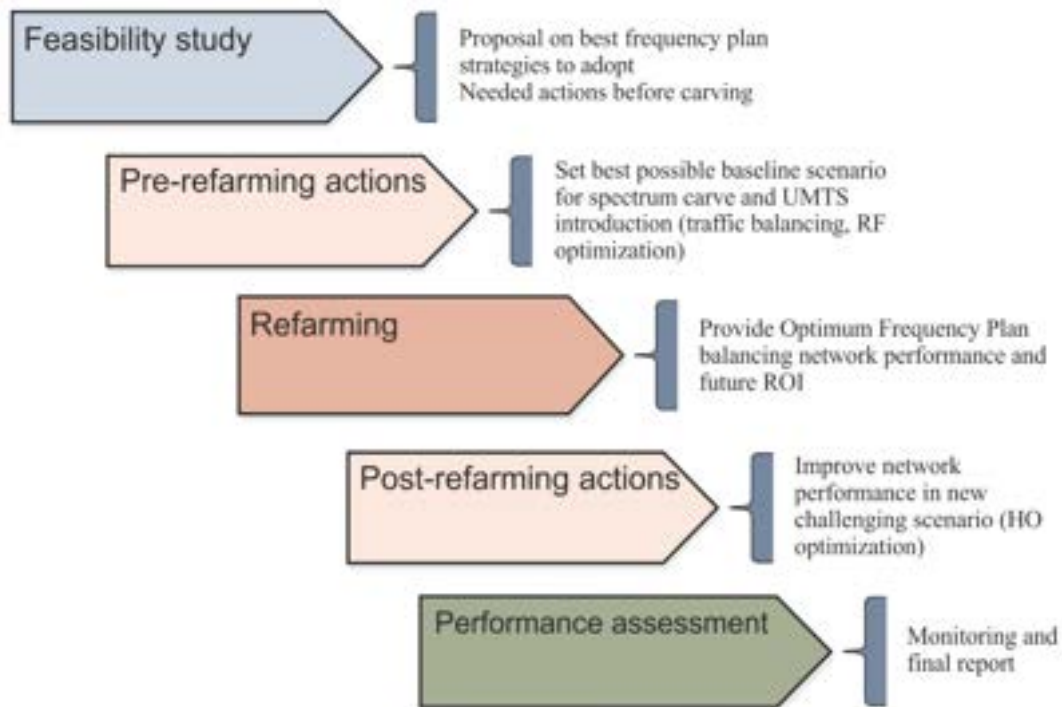
**Spectrum Migration Solution overview**

IMT-23

**Feasibility study**

The main target of this phase is to evaluate if the migration can be done within the acceptance criteria (i.e. agreed KPI levels for amount of spectrum to be released). The first task is to define the required spectrum reduction, typically dependent on the following factors:

- Operator restrictions
- Maturity of the network
- Expected traffic growth
- Network evolution

**Pre re-farming actions**

In this phase, using output from the feasibility study, a complete set of actions will be proposed in order to establish the best baseline scenario for the implementation of a new frequency plan after the spectrum carving. These actions typically includes RF Optimization and RRM Optimization.

There are several functions which can be used to aid in the achievement of the objectives (capacity, interference and traffic management). These functions will reduce the interference levels or improve the network's ability to cope with the increased interference.

**Frequency plan elaboration and implementation**

In this phase the final frequency will be implemented guided by the strategies defined in the previous phase. This phase includes the following parts:

- Frequency Plan
- Updated Neighbour List
- Fall-back plan
- Fall back to the previous frequency plan



- A fast reactive process to identify and troubleshoot the worst performing sectors

### **Post re-farming actions**

A second round of optimization actions may be proposed after the implementation of the Re-farmed frequency plan. In order to understand the real scope of this phase, a Performance Analysis must be carried for two main reasons:

- Ensure no severe degradation is present post-Re-farming. If this is the case, then a fall-back plan will be auctioned.
- Acknowledge the necessary actions to be carried out in order to meet the agreed Acceptance criteria.

### **Performance assessment**

After Implementation, the network will be monitored mainly through the Operational Support Systems (OSS)-based tool. Other tools may be also utilized for specific monitoring tasks.

## **6.2.3 Some case studies**

Operators in Europe and Asia are re-farming parts of their GSM spectrum to allow new technology introduction. The general trend has been to re-use 900 MHz for IMT-2000 and 1 800 MHz for IMT. The driver for IMT-2000 in 900 MHz is to improve coverage since low frequency spectrum has better coverage characteristics compared with the higher frequencies thereby allowing both deeper and broader coverage. The device eco-system for 900 MHz is also very strong.

In many markets, the motivation for deploying IMT in their existing 1 800 MHz band is a combination of capacity relief and to demonstrate market leadership by launching IMT services before new spectrum, such as 2 600 MHz, is available. The device eco-system for IMT in 1 800 is also very strong, particularly at the high end of the market.

### **6.2.3.1 General scenarios**

The ultimate arrangement that mobile broadband networks will take, will vary from case to case. As an illustration of the possible alternative routes that could be taken by three different operators, Figures 24 and 25 show the start points and end points of the evolution to a high-performance mobile broadband network using different radio-access technologies.

FIGURE 24

**Starting frequency band assignment and technology deployment for the operator**

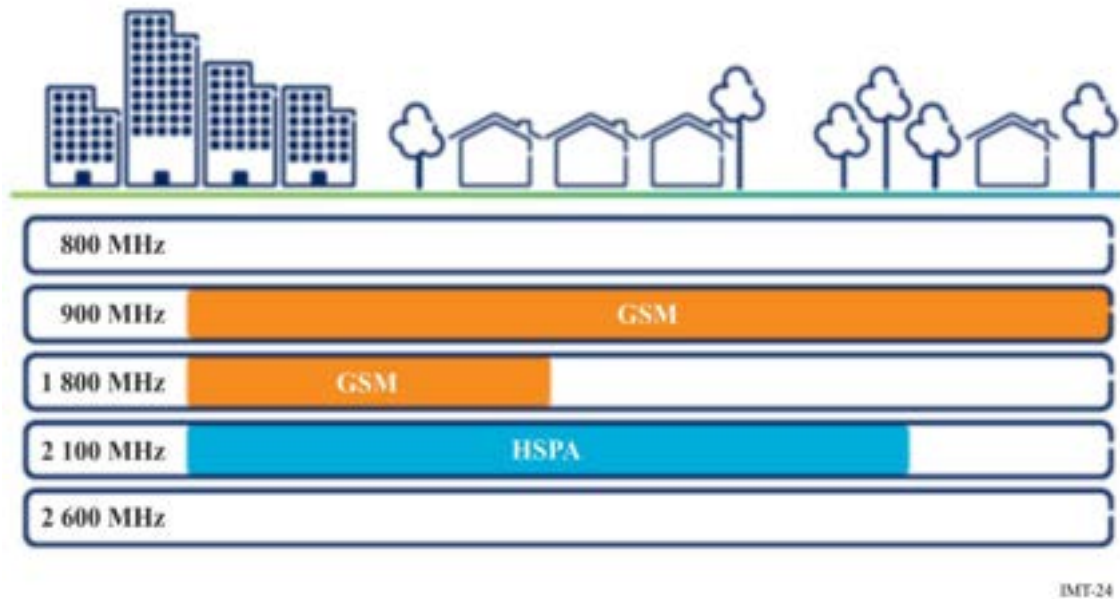

IMT-24

FIGURE 25

#### Evolved frequency band allocation and deployment for the operator

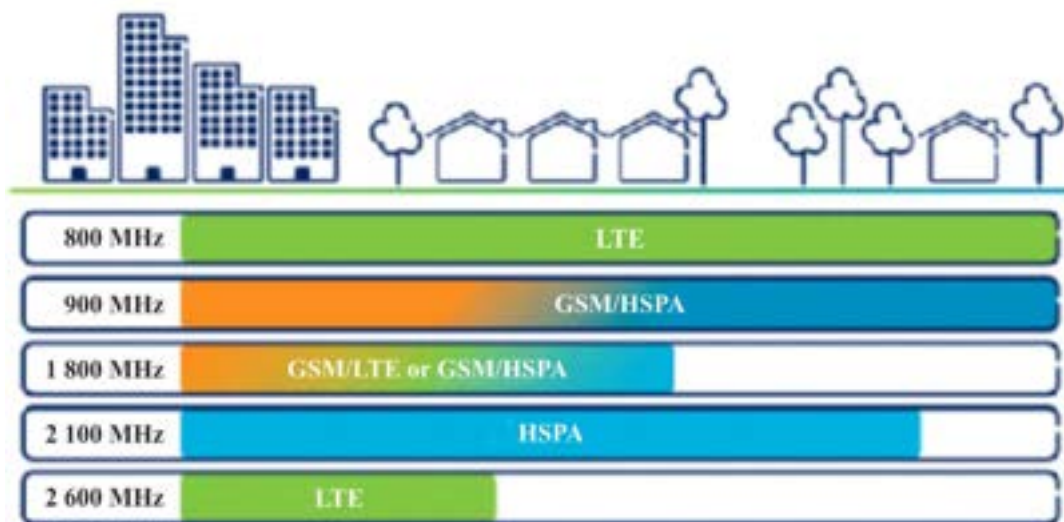

IMT-25

Typical European frequencies are used to illustrate the strategies for this evolution.

**Scenario 1:** This operator has no early access to either 2 600 MHz or 800 MHz spectrum for IMT (e.g. LTE). Here, the first step is to re-farm the 900 MHz spectrum to IMT-2000 (e.g. HSPA) in order to boost IMT-2000 coverage and capacity, especially in rural areas. As GSM traffic diminishes as a result of the greater IMT-2000 (e.g. HSPA) capacity, the operator can re-farm the 1 800 MHz spectrum either for IMT (e.g. LTE) or IMT-2000 (e.g. HSPA) to provide high-performance mobile broadband in urban and suburban areas. The technology choice will depend on the operator's market position, the current and projected device fleet, the ability to serve mass-market volumes of IMT-2000 (e.g. HSPA) smartphones in existing 3GPP bands, and the availability of other bands for IMT (e.g. LTE). In this scenario, the operator is able to roll out IMT (e.g. LTE) in other bands as it becomes available.

**Scenario 2:** This operator has already deployed IMT-2000 (e.g. WCDMA/HSPA) in the 900 MHz, as well as in the 2 100 MHz band. The total spectrum in these deployments is sufficient to cater for mass IMT-2000 (e.g. HSPA) smartphone uptake. By driving the uptake of IMT-2000 capable devices that use IMT-2000 access for voice and data, and rolling out GSM efficiency improvements, GSM traffic can be served within the 900 MHz spectrum. This frees up the 1 800 MHz spectrum for IMT (e.g. LTE) deployment.

**Scenario 3:** This operator has early access to 2 600 MHz spectrum for IMT (e.g. LTE), as well as the option for rolling out IMT (e.g. LTE) in the Digital Dividend 800 MHz band (made available following the shutdown of Europe’s analogue TV networks). The operator’s first step is to re-farm 900 MHz spectrum to IMT-2000 (e.g. WCDMA/HSPA) to provide wider and deeper IMT-2000 coverage and capacity, especially for rural and indoor areas. Increasing use of IMT-2000 (e.g. WCDMA/HSPA) in the wide area gradually reduces load on the GSM/EDGE network.

In addition, the operator deploys IMT (e.g. LTE) in the 2 600 MHz band in urban hotspots to provide a high-speed mobile-broadband service to complement the IMT-2000 (e.g. HSPA) access. After this, the operator rolls out IMT (e.g. LTE) in the 800 MHz band to provide high-performance broadband in the wide area, including rural areas.

Ultimately, when GSM traffic has diminished significantly, the operator can re-farm the 1 800 MHz spectrum for IMT (e.g. LTE) as well to provide a further capacity and boost coverage. Alternatively, if the need for additional IMT-2000 (e.g. HSPA) capacity is more pressing at this time, the operator has the option of deploying IMT-2000 (e.g. HSPA) in the 1 800 MHz spectrum.

### 6.2.3.2 One example of network migration to LTE 1800

One operator in Australia’s key strategies following the 2006 launch of its WCDMA network was a concerted effort to move GSM users to the new network. Many factors lay behind this strategy, including network rationalization, coherent branding and operational efficiency. To provide incentives for users to move to IMT-2000, the operator relied on a variety of options, such as free handset upgrades and attractive “no premium” pricing plans. As users moved to more advanced technology, they became more likely to adopt new services. But perhaps the most significant outcome was operator’s ability to “empty” its GSM network and re-farm the 1 800 MHz spectrum to launch Australia’s first LTE network in September 2011.

Since the network launch, the volume of traffic in this operator’s mobile network has doubled every year. In late 2010, through a capacity modelling tool, the operator forecast that the network capacity would run out before the new 700 MHz spectrum – primed for LTE – became available. So something had to be done – and fast.

Spectrum re-farming was not new to this operator. It had already successfully introduced WCDMA on re-farmed 850 MHz and built a healthy ecosystem in the process. In pioneering a global 1 800 MHz LTE ecosystem, the operator took the same approach, playing an active role by working in conjunction with infrastructure suppliers, device and chipset manufacturers and industry bodies. Today, 1 800 MHz has become the most popular LTE band worldwide.

When this operator launched the nation’s first LTE network, it was seen by industry observers as a six month head start on competitors that could consolidate the company’s already dominant position. The launch was as much a result of the operator’s engineering strategy as of its business strategy.

For additional information related to the migration please refer to Annex G – Technology migration in a given frequency band.

### 6.2.3.3 Example of network migration to IMT in 900 MHz band

In Viet Nam, UMTS systems have been deployed in the 2 100 MHz band. Due to high deployment cost of the UMTS 2 100 MHz in rural areas of Viet Nam, mobile broadband services in these areas were not adequate. Recently, operators showed strong demand to deploy mobile broadband systems in GSM 900 MHz band for rural coverage mainly because of excellent propagation characteristic and low deployment cost. As GSM 900 MHz systems have national coverage, it is quite efficient to reuse the existing infrastructure for IMT systems in the same band.

The requests from operators triggered re-assessment of frequency planning from the Ministry of Information and Communications as Frequency Planning for this band is for GSM systems only. Operators were notified that the Ministry would re-consider the planning for 900 MHz band. Operators holding licenses in the 900 MHz band were allowed to carry out IMT systems trials in small scale in the same band. Operators chose to trial UMTS in the 900 MHz.

Operators' trial report showed excellent UMTS coverage, comparable data service with UMTS service in 2 100 MHz band, and all Key Performance Indicators were met.

Measurements of the quality of the existing GSM service indicated that there was no degradation in GSM's voice services.

At the same time, the Ministry had comprehensively studied the planning of 900 MHz band for IMT. The result was that it would be beneficial to the society as a whole, especially for rural areas, to deploy IMT in 900 MHz band. The Ministry distributed public request for comment of the new policy and organized workshop to have operators' opinion.

With the success of operators' trial results and consensus responses of stakeholders, the Ministry enforced a new circular to allow the operators holding 900 MHz license to deploy IMT system in the same band.

The Ministry also informed the operators with the intention of long term frequency arrangement for IMT 900 MHz following 5 MHz blocks plan.

The operators were directed to follow the 5 MHz block plan as much as practical to avoid unnecessary cost and rearrangement issues in the future.

Figure 26 illustrates the IMT carrier arrangement in the 900 MHz band co-existing with GSM.

FIGURE 26

**Example of re-farming 900 MHz band in the transition phase**

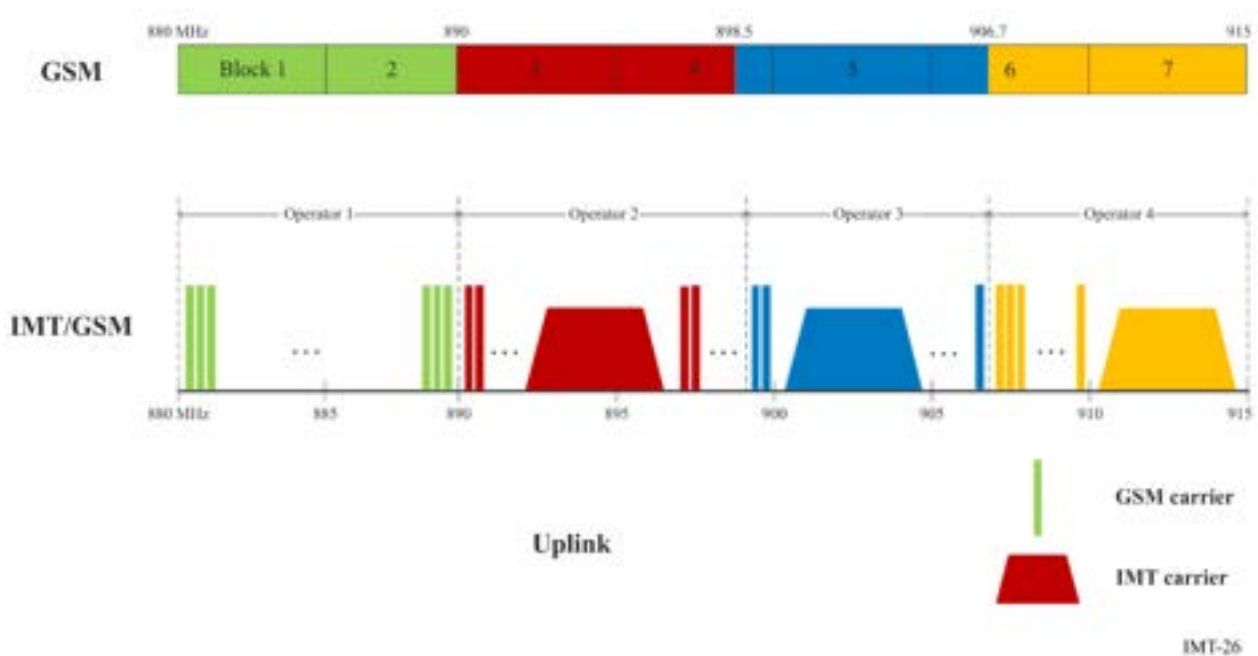

### 6.3 Choice of technology in the identified IMT bands

#### 6.3.1 IMT technology considerations

It is important to consider bandwidth, coverage and capacity requirements when intending to implement a new IMT system. Considering various deployment possibilities, aggregation of spectrum used separately for FDD

or TDD operations may be an efficient method to increase the utilization of the spectrum resource. FDD and TDD aggregation needs to be able to operate in the following scenarios:

- Multiple carriers on co-located sites, part of which are FDD carriers and the rest are TDD carriers.
- Different types of carriers on different sites, e.g. FDD carrier on macro sites, and TDD carriers on small cells.

For development of systems that can support FDD and TDD aggregation, techniques must be developed to enable legacy user equipment (UE) that operates on either FDD or TDD networks to be able to work on the FDD-TDD aggregated network. Eventually future-evolved UE that support FDD and TDD aggregation could enjoy the increased peak data rate.

For more information on criteria leading to technology decisions, please refer to section 7.

### 6.3.2 Satellite component of IMT

IMT consists of both terrestrial component and satellite component radio interfaces. The terrestrial and satellite components are complementary, with the terrestrial component providing coverage over areas of land mass with population density considered to be large enough for economic provision of terrestrially-based systems, and the satellite component providing service elsewhere by a virtually global coverage, especially with strength in providing coverage in the sea, islands, mountainous districts, and sparsely-populated areas. The ubiquitous coverage of IMT can therefore be realized using a combination of satellite and terrestrial radio interfaces.

The satellite component of IMT encompasses both IMT-2000 and IMT-Advanced. The radio interfaces for the satellite component of IMT-2000 are identified in Recommendation ITU-R M.1850-1, including:

- Satellite radio interface A (SRI-A)
- Satellite radio interface B (SRI-B)
- Satellite radio interface D (SRI-D)
- Satellite radio interface E (SRI-E)
- Satellite radio interface F (SRI-F)
- Satellite radio interface G (SRI-G)
- Satellite radio interface H (SRI-H).

The radio interfaces for the satellite component of IMT-Advanced have been developed by ITU-R. Two radio interfaces are identified:

- BMSat
- SAT-OFDM.

For more information on radio interfaces for the satellite component of IMT-Advanced, please refer to Recommendation ITU-R M.2047 – Detailed specifications of the satellite radio interfaces of International Mobile Telecommunications-Advanced (IMT-Advanced), and to Report ITU-R M.2279 – Outcome of the evaluation, consensus building and decision of the IMT-Advanced satellite process (Steps 4 to 7), including characteristics of IMT-Advanced satellite radio interfaces.

The specifications of the radio interfaces for the satellite component of IMT could also be adopted by other MSS systems and applied in other bands for MSS.

## 6.4 Deployment planning

A key to supporting the increasing data requirements of IMT systems is the provision of sufficient backhaul capacity to avoid the creation of a bottleneck. Fibre and wireless systems both have roles to play in backhaul of IMT data. Fibre has a greater capacity and typically lower operating expenses, while wireless backhaul is quicker and easier to install, especially in the case where many small cells are being connected. In addition, wireless technologies have the potential to provide lower latencies given the difference in propagation speeds between fibre and wireless.

Although the proportion of data traffic backhauled by fibre is increasing, the absolute number of fixed wireless backhaul links is nevertheless increasing rapidly, particularly systems comprising a small number of hops in support of small mobile cells in urban and other high usage areas.

For more detailed information on the design of wireless backhaul systems please refer to Annex D – Description of Wireless Backhaul Systems.

## **7 Criteria leading to technology decisions**

### **7.1 Spectrum implications, channelization and bandwidth considerations**

The current availability of frequency bands and amount of bandwidth differs across Member States and regions and this leads to many challenges such as roaming, device complexity, lack of economics of scale, and interference. It is recognized that finding and assigning contiguous, broader and harmonized frequency bands which are aligned with future technology development can reduce these challenges.

Also, pursuing greater harmonization with larger contiguous frequency bands will support continued introduction of mobile devices with longer battery life while improving spectrum efficiency; and potentially reducing cross border interference.

Flexible spectrum usage can provide technical solutions to address the growing traffic demand in the future and allow more efficient use of radio resources including the limited spectrum resources. Flexible spectrum usage can improve the frequency efficiency, which includes aspects such as cognitive radio techniques, Authorized Shared Access (ASA), and joint management of multiple radio access technologies (RATs).

### **7.2 Importance of multi-mode/multi-band solutions**

The increasing availability of multi-radio mobile devices has fuelled a growing trend towards exploiting multiple RATs to address capacity as well as connectivity limitations. Integration of multiple radio access technologies could help seamlessly integrate the new spectrum bands, existing licensed bands, and unlicensed bands to meet capacity and service demands and provide better user experience.

Multi-radio networks also offer an opportunity for future IMT systems to support all footprints: wide area networks (WANs), local area networks (LANs), and personal area networks (PANs) in a fashion that is transparent to the end user.

### **7.3 Technology development path**

ITU-R WP 5D has a process in place to continually revise Recommendations ITU-R M.1457, ITU-R M.2012 and ITU-R M.2150 as several technologies have and will continue to introduce technological advancements to both established and more recent IMT systems. Member States can follow these advancements in many ways including tracking the latest revisions of these Recommendations. Advances in the mobile industry have been significant over the past decade and the ability to introduce these technologies advancements quickly have contributed to the significant growth in mobile broadband data usage.

### **7.4 Backhaul considerations**

In this context backhaul means the aggregate of all the traffic being transported to the core network. As traffic demands for mobile broadband communications increases, backhaul is increasingly becoming an important infrastructure in the IMT network architecture that requires special consideration. Backhaul performance not only affects the data throughput available to users, but also the overall performance of the radio-access network.

High performance backhaul with low latency enables tighter coordination between nodes, which in turn uses available spectrum more efficiently. Networks with large numbers of (small) cell sites require backhaul solutions that can use a selection of physical transmission media, including microwave, fibre and wireless connectivity.

Backhaul solutions should not limit the radio access network, which means that there should be adequate backhaul capacity provision at the network cell sites. In addition, backhaul solutions should have sufficient end-to-end performance to meet the desired user quality of experience (QoE) everywhere for the provision of mobile broadband.

## **7.5 Technology neutrality**

With the rapid changes and developments occurring in the mobile sector, a technology neutral approach in developing policies and regulations for the wireless communications sector will support the continued and robust growth of mobile broadband which will directly benefit the entire community, both the public and private sectors. Policies and regulations that mandate or only address specific technology solutions frequently become impediments for continued growth, limit competition and stifle innovation.





## ANNEX A

**Abbreviations, acronyms, interface and reference points****A.1 Abbreviations and acronyms**

ACI	Adjacent Channel Interference
ACLR	Adjacent Channel Leakage Ratio
ACS	Adjacent Channel Selectivity
A-GPS	Assisted GPS
ANSI	American National Standard Institute
ARIB	Association of Radio Industries and Businesses
ATIS	Alliance for Telecommunications Industry Solutions
AuC	Authentication centre
B2B	Business to Business
BCCH	Broadcast Control Channel
BSC	Base Station Controller
BSSAP	Base Station Subsystem Application Part
BSS	Base station system
BTS	Base Transceiver Station
CAGR	Compound annual growth rate
CCSA	China Communications Standards Association
CDMA	Code Division Multiple Access
CEPT	European Conference of Postal and Telecommunications Administrations
CGI	Computer-generated imagery
CGI	Cell Global Identifier
CI	Cell Identity
CID	Cell ID
CN	Core network
CS-MGW	Circuit switched – Media gateway function
DCCH	Dedicated Control Channel
CDR	Call-detail Record
DECT	Digital Enhanced Cordless Telecommunications
DL	Downlink
DME	Distance Measuring Equipment
EB	Exabyte
EDGE	Enhanced Data rate for GSM Evolution
EGPRS	Enhanced GPRS

eHRPD	Evolved High Rate Packet Data
EHS	Electromagnetic Hyper Sensitivity
EIA	Electronic Industries Association
E interface	mobile switching centre server (MSC server) – mobile switching centre server (MSC server)
EIR	Equipment Identity Register
eNB	enhanced Node B
EPC	Evolved Packet Core
E-SMLC	Evolved Serving Mobile Location Centre
ETSI	European Telecommunications Standards Institute
E-UTRAN	Evolved Universal Terrestrial Radio Access Network
FDD	Frequency Division Duplex
FDMA	Frequency Division Multiple Access
GGSN	Gateway GPRS Support Node
GMLC	Gateway Mobile Location Centre
GMSC	Gateway mobile Switching Centre
GPRS	General Packet Radio System / General Packet Radio Service
GPS	Global Positioning System
GSA	Global Mobile Suppliers Association
GSM	Global System for Mobile Communications
GSMA	GSM Association
GT	Global Title
HLR	Home Location Register
HPCRF	PCRF in the home PLMN
HRPD	High Rate Packet Data
HSPA	High Speed Packet Access
HSS	Home Subscriber Server
ICIC	Inter-Cell Interference Coordination
ICT	Information and Communication Technology
IEC	International Electrotechnical Commission
IEEE	Institute of Electrical and Electronics Engineers
IOS	Interoperability Specification
IP	Internet Protocol
ISO	International Organization for Standardization
IWU	Interworking Unit
KPI	Key Performance Indicator
LAC	Location Area Code
LBS	Location Based Services

L-DACS	L-band Digital Aeronautical Communication
LLC	Logical Link Control
LMH-BWA	Land Mobile (including Wireless Access) – Volume 5: Deployment of Broadband Wireless Access Systems
LMU	Location Measurement Unit
LTE	Long Term Evolution
MAC	Medium Access Controller
MC	Multi-Carrier
MCC	Mobile Country Code
MCL	Minimum Coupling Loss
ME	Mobile Equipment
M2M	Machine-to-Machine
MME	Mobility Management Entity
MNC	Mobile Network Code
MSC	Mobile Switching Centre (also appears as “Mobile-services Switching Centre”)
MSCe	Mobile Switching Centre emulation
NAS	Non-Access-Stratum
NMR	Network Management Reports
OECD	Organization for Economic Co-operation and Development
OFDMA	Orthogonal Frequency Division Multiple Access
O&M	Operation and Maintenance
OOBE	Out-Of-Band Emission
OSC	Orthogonal Sub-channels
OSI	Open System Interconnection
OSS	Operational Support Systems
O-TDOA	Observed Time Difference of Arrival
PB	Petabyte
PCRF	Policy and Charging Rules Function
PDCP	Packet Data Convergence Protocol
PDN	Packet Data Network
PDN GW	gateway which terminates the SGi interface towards the PDN
PHY	Physical Layer
PLMN	Public Land Mobile Network
PPDR	Public Protection and Disaster Relief
PS	Packet Switched
PSTN	Public Switched Telephone Network
QoS	Quality of Service
RBS	Radio Base Station

RF	Radio Frequency
RFPM	RF Pattern Printing
RIT	Radio Interface Technology
RLC	Radio Link Controller
RNC	Radio Network Controller
RNS	Radio Network Subsystem (also appears as "Radio Network System")
RR	Radio Regulations
RRC	Radio Resource Controller
RRM	Radio Resource Management
RSVP	Resource Reservation Protocol
RTT	Radio Transmission Technologies
RTT	Round Trip Time
SDO	Standard Development Organization
SDU	Selection/Distribution Unit; Service Data Unit
SGSN	serving GPRS support node
S-GW	Serving Gateway
SIM	GSM Subscriber Identity Module; Specialised Information Model
SLP	SUPL Location Platform
SMLC	Serving Mobile Location Centre
SMS	Short Message Service
SMS-GMSC	SMS gateway MSC
SMS-IWMSC	SMS Interworking MSC
STP	Signalling Transfer Point
SUPL	Secure User Plane Location
TA	Timing Advance
TCH	Traffic Channel
TDD	Time Division Duplex
TDMA	Time Division Multiple Access
TDMA-SC	Time Division Multiple Access – Single Carrier
TD-SCDMA	Time Division Synchronous CDMA
TIA	Telecommunications Industry Association
TOM	Tunnelling Of Messages
TTA	Telecommunications Technology Association
TTC	Telecommunication Technology Committee
UE	User Equipment
UL	Uplink
UMTS	Universal Mobile Telecommunications System

USIM	Universal Subscriber Identity Module
U-TDOA	Uplink Time Difference of Arrival
UTRAN	Universal Terrestrial Radio Access Network
UWC	Universal Wireless Communications Consortium
VAMOS	Voice services over Adaptive Multi-user channels on One Slot
VLR	Visitor location register
VPCRF	PCRF in the visited PLMN
WCDMA	Wideband CDMA
WMAN	Wireless Metropolitan Area Networking

## A.2 Interface

A	mobile switching centre (MSC) – base station system (BSS)
<i>Abis</i>	base station controller (BSC) – base transceiver station (BTS)
A1	carries signalling information between the call control and mobility management functions of the circuit-switched MSC and the call control component of the BS (BSC).
A1p	carries signalling information between the call control and mobility management functions of the MSCe and the call control component of the BS (BSC).
A2	provides a path for user traffic and carries 64/56 kbit/s PCM information (for circuit-oriented voice) or 64 kbit/s Unrestricted Digital Information (UDI, for ISDN) between the Switch component of the circuit-switched MSC and the Selection/Distribution Unit (SDU) function of the BS.
A2p	provides a path for packet-based user traffic sessions and carries voice information via IP packets between the MGW and the BS.
A3	transports user traffic and signalling for inter-BS soft/softer handoff when a target BS is attached to the frame selection function within the source BS.
A5	provides a path for user traffic for circuit-oriented data calls between the source BS and the circuit-switched MSC.
A7	carries signalling information between a source BS and a target BS for inter-BS soft/softer handoff.
A8	carries user traffic between the BS and the PCF.
A9	carries signalling information between the BS and the PCF.
A10	carries user traffic between the PCF and the PDSN.
A11	carries signalling information between the PCF and the PDSN
B	an internal interface defined for modelling purposes
C	Gateway mobile switching centre server (GMSC server) – Home location register (HLR)
D	visitor location register (VLR) – home location register (HLR)
F	mobile switching centre server (MSC server) – equipment identity register (EIR)
G	visitor location register (VLR) – visitor location register (VLR)
G <sub>b</sub>	serving GPRS support node (SGSN) – base station system (BSS)
G <sub>c</sub>	home location register (HLR) – gateway GPRS support node (GGSN)
G <sub>d</sub>	interface between the SGSN and the SMS Gateway
G <sub>f</sub>	equipment identity register (EIR) – serving GPRS support node (SGSN)
G <sub>n</sub>	gateway GPRS support node (GGSN) – serving GPRS support node (SGSN)

G <sub>p</sub>	serving GPRS support node (SGSN) – external data network
G <sub>r</sub>	home location register (HLR) – serving GPRS support node (SGSN)
G <sub>s</sub>	mobile switching centre (MSC)/visitor location register (VLR) – serving GPRS support node (SGSN)
G <sub>xc</sub>	S-GW – PCRF/VPCRF
Iu	communication interface between the RNC and the Core Network Interface (Mobile switching centre and Serving GPRS Support Node).
Iub	RNC – Node B
IuCS	mobile switching centre (MSC) – RNS or BSS
IuPS	serving GPRS support node (SGSN) – RNS or BSS
Iur	A logical interface between two RNC whilst logically representing a point-to-point link between RNC, the physical realization may not be a point-to-point link.
Lb/Iupc	interface between SMLC and RSC/RNC
Lg/SLg	interface between GMLC and MSC/MME
Lh/SLh	interface between GMLC and HLR/HSS
S1	standardized interface between eNB – the Evolved Packet Core (EPC).
S1-MME	MME – E-UTRAN
S1-u	interface connecting the eNB to the S-GW by means of the user-plane part
S1-c	interface connecting the eNB to the MME by means of the control-plane part
S3	MME – SGSN
S4	S-GW – SGSN
S5	S-GW – PDN GW
S6a	MME – HSS
S6d	home location register (HLR) – serving GPRS support node (SGSN)
S8	S-GW – PDN GW S8 (the inter-PLMN variant of S5)
S9	HPCRF – VPCRF
S10	MME – MME
S11	MME – S-GW
SLs	interface between E-SMLC and MME
Um	air interface between BTS and MS
Uu	Radio interface between UTRAN and the user equipment
X2	supporting the exchange of signalling information between two eNBs, and mainly used to support active-mode mobility.

### **A.3 Reference point**

B	interface between MSC and the VLR
C	interface between the MSC and the HLR
D	interface between the VLR and HLR
d	interface between an IAP and the DF
D <sub>1</sub>	interface between the OTAF and the VLR
D <sub>i</sub>	interface between: <ul style="list-style-type: none"> <li>– The IP and the ISDN</li> <li>– The IWF and the ISDN</li> </ul>

	– The MSC and the ISDN [ESBE]
	– The SN and the ISDN
E	interface between the MSC and the MSC
E <sub>3</sub>	interface between the MPC and the MSC
E <sub>5</sub>	interface between the MPC and the PDE
E <sub>9</sub>	interface between the MPC and the SCP
E <sub>11</sub>	interface between the CRDB and the MPC
E <sub>12</sub>	interface between the MSC and the PDE
e	interface between the CF and the DF
F	interface between the MSC and the EIR
G	interface between the VLR and the VLR
G <sub>i</sub>	GGSN – packet data networks
G <sub>x</sub>	PCEF – PCRF/H-PCRF/V-PCRF
H	interface between the HLR and the AC
I	interface between the CDIS and the CDGP
J	interface between the CDGP and the CDCP
K	interface between the CDGP and the CDRP
M <sub>1</sub>	interface between the SME and the MC
M <sub>2</sub>	MC to MC interface
M <sub>3</sub>	SME to SME interface
M <sub>c</sub>	mobile switching centre server (MSC Server) –circuit switched media gateway (CS-MGW)
N	interface between the HLR and the MC
N <sub>1</sub>	interface between the HLR and the OTAF
N <sub>b</sub>	circuit switched media gateway (CS-MGW) – circuit switched media gateway (CS-MGW)
N <sub>c</sub>	mobile switching centre server (MSC server) – gateway mobile switching centre server (GMSC server)
O <sub>1</sub>	interface between an MWNE and the OSF
O <sub>2</sub>	interface between an OSF and the OSF
P <sub>1</sub>	interface between: <ul style="list-style-type: none"> <li>– The AAA and the AAA,</li> <li>– The AAA and the PDN,</li> <li>– The IWF and the PDN,</li> <li>– The MSC and the PDN, plus</li> <li>– The PDSN and the PDN.</li> </ul>
Q	interface between the MC and the MSC
Q <sub>1</sub>	interface between the MSC and the OTAF
R <sub>x</sub>	the application function – the policy and charging rule function (PCRF)
S12	S-GW – UTRAN
S13	MME – EIR
SG <sub>i</sub>	PDN GW – packet data networks
T <sub>1</sub>	interface between the MSC and the SCP
T <sub>2</sub>	interface between the HLR and the SCP

T <sub>3</sub>	interface between the IP and the SCP
T <sub>4</sub>	interface between the HLR and the SN
T <sub>5</sub>	interface between the IP and the MSC
T <sub>6</sub>	interface between the MSC and the SN
T <sub>7</sub>	interface between the SCP and the SN
T <sub>8</sub>	interface between the SCP and the SCP
T <sub>9</sub>	interface between the HLR and the IP
V	interface between the OTAF and the OTAF
X	interface between the CSC and the OTAF
Y	interface between a Wireless Network Entity (WNE) and the IWF
Z	interface between the MSC and the NPDB
Z1	interface between the MSC and the VMS
Z2	interface between the HLR and the VMS
Z3	interface between the MC and the VMS



## ANNEX B

### Reference publications

#### B.1 ITU publications

##### B.1.1 ITU Recommendations

###### Terrestrial IMT Recommendations:

- Recommendation ITU-R M.687 – International Mobile Telecommunications-2000 (IMT-2000)
- Recommendation ITU-R M.819 – International Mobile Telecommunications-2000 (IMT-2000) for developing countries
- Recommendation ITU-R M.1036 – Frequency arrangements for implementation of the Terrestrial component of International Mobile Telecommunications (IMT) in the bands identified for IMT in the Radio Regulations (RR)
- Recommendation ITU-R M.1079 – Performance and quality of service requirements for International Mobile Telecommunications-2000 (IMT 2000) access networks
- Recommendation ITU-R M.1224 – Vocabulary of terms for International Mobile Telecommunications (IMT)
- Recommendation ITU-R M.1456 – Minimum performance characteristics and operational conditions for high altitude platform stations providing IMT-2000 in the bands 1 885-1 980 MHz, 2 010-2 025 MHz and 2 110-2 170 MHz in Regions 1 and 3 and 1 885-1 980 MHz and 2 110-2 160 MHz in Region 2
- Recommendation ITU-R M.1457 – Detailed specifications of the terrestrial radio interfaces of International Mobile Telecommunications-2000 (IMT-2000)
- Recommendation ITU-R M.1545 – Measurement uncertainty as it applies to test limits for the terrestrial component of International Mobile Telecommunications-2000
- Recommendation ITU-R M.1580 – Generic unwanted emission characteristics of base stations using the terrestrial radio interfaces of IMT 2000
- Recommendation ITU-R M.1581 – Generic unwanted emission characteristics of mobile stations using the terrestrial radio interfaces of IMT 2000
- Recommendation ITU-R M.1579 – Global circulation of IMT terrestrial terminals
- Recommendation ITU-R M.1635 – General methodology for assessing the potential for interference between IMT-2000 or systems beyond IMT-2000 and other services
- Recommendation ITU-R M.1641 – A methodology for co-channel interference evaluation to determine separation distance from a system using HAPS to a cellular system to provide IMT-2000 service
- Recommendation ITU-R M.1645 – Framework and overall objectives of the future development of IMT-2000 and systems beyond IMT-2000
- Recommendation ITU-R M.1646 – Parameters to be used in co-frequency sharing and pfd threshold studies between terrestrial IMT-2000 and BSS (sound) in the 2 630-2 655 MHz band
- Recommendation ITU-R M.1654 – A methodology to assess interference from broadcasting satellite service (sound) into terrestrial IMT 2000 systems intending to use the band 2 630-2 655 MHz
- Recommendation ITU-R M.1768 – Methodology for calculation of spectrum for the terrestrial component of International Mobile Telecommunications
- Recommendation ITU-R M.1822 – Framework for services supported by IMT

- Recommendation ITU-R M.2012 – Detailed specifications of the terrestrial radio interfaces of International Mobile Telecommunications Advanced (IMT-Advanced)
- Recommendation ITU-R M.2070 – Generic unwanted emission characteristics of base stations using the terrestrial radio interfaces of IMT-Advanced
- Recommendation ITU-R M.2071 – Generic unwanted emission characteristics of mobile stations using the terrestrial radio interfaces of IMT-Advanced
- Recommendation ITU-R M.2083 – IMT Vision – "Framework and overall objectives of the future development of IMT for 2020 and beyond"
- Recommendation ITU-R M.2090 – Specific unwanted emission limit of IMT mobile stations operating in the frequency band 694-790 MHz to facilitate protection of existing services in Region 1 in the frequency band 470-694 MHz
- Recommendation ITU-R M.2101 – Modelling and simulation of IMT networks and systems for use in sharing and compatibility studies
- Recommendation ITU-R M.2150 – Detailed specifications of the terrestrial radio interfaces of International Mobile Telecommunications-2020 (IMT-2020)

For more information please refer to the Guide to the use of the ITU-R texts relating to the terrestrial component of IMT: <https://www.itu.int/oth/R0A060000AA/en>

## **B.1.2 ITU Reports**

### **Terrestrial IMT (and other, related) Reports**

- Report ITU-R M.2038 – Technology trends (as they relate to IMT-2000 and systems beyond IMT-2000)
- Report ITU-R M.2039 – Characteristics of terrestrial IMT-2000 systems for frequency sharing/interference analyses
- Report ITU-R M.2072 – World mobile telecommunication market forecast
- Report ITU-R M.2078 – Estimated spectrum bandwidth requirements for the future development of IMT-2000 and IMT-Advanced
- Report ITU-R M.2079 – Technical and operational information for identifying spectrum for the terrestrial component of future development of IMT-2000 and IMT-Advanced
- Report ITU-R M.2242 – Cognitive radio systems specific for IMT systems
- Report ITU-R M.2243 – Assessment of the global mobile broadband deployments and forecasts for International Mobile Telecommunications
- Report ITU-R M.2375 – Architecture and topology of IMT networks
- Report ITU-R M.2410 – Minimum requirements related to technical performance for IMT-2020 radio interface(s)
- Report ITU-R M.2411 – Requirements, evaluation criteria and submission templates for the development of IMT-2020
- Report ITU-R M.2412 – Guidelines for evaluation of radio interface technologies for IMT-2020
- Report ITU-R M.2499 – Synchronization of IMT-2020 Time Division Duplex networks

For more information please refer to the Guide to the use of the ITU-R texts relating to the terrestrial component of IMT: <https://www.itu.int/oth/R0A060000AA/en>

## **B.1.3 ITU Handbooks**

ITU-R and its Working Parties developed a number of ITU-R Handbooks as follows:

- Handbook on Amateur and amateur-satellite services ([www.itu.int/pub/R-HDB-52](http://www.itu.int/pub/R-HDB-52))
- Handbook on Digital Radio-Relay Systems ([www.itu.int/pub/R-HDB-24](http://www.itu.int/pub/R-HDB-24))

- Handbook on Frequency adaptive communication systems and networks in the MF/HF bands ([www.itu.int/pub/R-HDB-40](http://www.itu.int/pub/R-HDB-40))
- Handbook on Land Mobile (including Wireless Access) Volume 1: Fixed Wireless Access ([www.itu.int/pub/R-HDB-25](http://www.itu.int/pub/R-HDB-25))
- Handbook on Land Mobile (including Wireless Access) Volume 2: Principles and Approaches on Evolution to IMT-2000/FPLMTS ([www.itu.int/pub/R-HDB-30](http://www.itu.int/pub/R-HDB-30))
- Handbook on Land Mobile (including Wireless Access) – Volume 3: Dispatch and Advanced Messaging Systems ([www.itu.int/pub/R-HDB-47](http://www.itu.int/pub/R-HDB-47))
- Handbook on Land Mobile (including Wireless Access) – Volume 4: Intelligent Transport Systems ([www.itu.int/pub/R-HDB-49](http://www.itu.int/pub/R-HDB-49))
- Handbook on Land Mobile (including Wireless Access) – Volume 5: Deployment of Broadband Wireless Access Systems ([www.itu.int/pub/R-HDB-57](http://www.itu.int/pub/R-HDB-57))
- Handbook on Migration to IMT-2000 Systems – Supplement 1 (Revision 1) of the Handbook on Deployment of IMT-2000 Systems ([www.itu.int/pub/R-HDB-46](http://www.itu.int/pub/R-HDB-46))
- Handbook on IMT-2000: Special Edition on CD-ROM ([www.itu.int/pub/R-HDB-37](http://www.itu.int/pub/R-HDB-37))

## **B.2 External publications**

### **B.2.1 UMTS Forum Reports**

- UMTS Forum Report 1, “A Regulatory Framework for UMTS”, 1997
- UMTS Forum Report 2, “The Path towards UMTS – Technologies for the Information Society”, 1998
- UMTS Forum Report 4, “Considerations of Licensing Conditions for UMTS Network Operations”, 1998
- UMTS Forum Report 5, “Minimum Spectrum Demand per Public Terrestrial UMTS Operator in the Initial Phase”, 1998
- UMTS Forum Report 6, UMTS/IMT-2000 Spectrum, 1998
- UMTS Forum Report 33, 3G Offered Traffic Characteristics, November 2003
- UMTS Forum Report 35, Mobile Market Evolution and Forecast: Long term sociological, social and economical trends, June 2004
- UMTS Forum Report 36, Benefits of Mobile Communications for the Society, June 2004
- UMTS Forum Report 37, “Magic Mobile Future 2010-2020”, April 2005
- UMTS Forum Report 38, “Coverage Extension Bands for UMTS/IMT-2000 in the bands between 470-600 MHz”, January 2005
- UMTS Forum Report 39, “The Global Market for High Speed Packet Access (HSPA): Quantitative and Qualitative analysis”, March 2006
- UMTS Forum Report 40, “Development of spectrum requirement forecasts for IMT-2000 and systems beyond IMT-2000 (IMT-Advanced)”, January 2006
- UMTS Forum Report 41, “Market Potential for 3G LTE”, July 2007
- UMTS Forum Report 42, “LTE Mobile Broadband Ecosystem: the Global Opportunity”, June 2009
- UMTS Forum Report 43, “Two Worlds Connected: Consumer Electronics Meets Mobile Broadband”, January 2011
- UMTS Forum Report 44, “Mobile Traffic Forecasts 2010-2020”, May 2011
- UMTS Forum White Paper “Spectrum for future development of IMT-2000 and IMT-Advanced”, 2012

**B.2.2 GSMA publications**

- GSMA mobile policy handbook
- GSMA mobile economy series
- Learn mobile spectrum (April 2017)
- Spectrum policy dictionary (April 2017)
- Spectrum policy
- Wireless backhaul spectrum positions (February 2021)
- Spectrum sharing positions (June 2021)
- Expanding mobile coverage
- WRC-23 IMT Agenda Items
- 3.5 GHz for 5G (October 2021)
- 6 GHz capacity to power innovation
- WRC-23 low band capacity
- mmWave 5G regional spotlights (July 2019)
- Study on Socio-Economic Benefits of 5G Services Provided in mmWave Bands (December 2018)
- 26 GHz and 28 GHz for 5G
- L Band for mobile broadband
- GSMA driving the digital revolution with improved mobile coverage (September 2020)
- 5G spectrum guide
- 5G spectrum positions (March 2021)
- Estimating mid band spectrum needs (July 2021)
- Mobile networks industry verticals (July 2021)
- 5G TDD synchronisation (April 2020)
- Spectrum pricing policy positions (May 2021)
- Impact of spectrum prices on consumers (September 2019)
- Effective spectrum pricing (February 2017)
- Spectrum pricing in developing countries (July 2018)
- Spectrum leasing 5G Era (January 2022)
- Roadmaps for awarding 5G spectrum in the MENA region (January 2022)
- Roadmaps for 5G Spectrum: Sub-Saharan Africa (August 2021)
- 5G and the 3.3-3.8 GHz Range in Latin America (November 2020)
- Auction Best Practice GSMA Public Policy Position (September 2021)

## ANNEX C

### Applications and services

#### C.1 Location based application and services

Location based application and services helps in determining the geographical position of a mobile phone/device, and delivers the position to the application requesting this information. Location based systems can be broadly divided into: a) network based; b) handset based and c) hybrid.

- a) Network based: Network-based techniques utilize the service provider's network infrastructure to identify the location of the handset. The advantage of network-based techniques (from mobile operator's point of view) is that they can be implemented without specific support for LBS (Location Based Services) from handsets. The accuracy of network-based techniques is dependent on the inter site distance and number of neighbouring base station cells.
- b) Handset based: The handset based technique generally uses GPS. In this case location determination calculation is done by the handset, and thus location information is generally more precise.
- c) Hybrid positioning systems use a combination of network-based and handset-based technologies for location determination. One example would be Assisted GPS, which uses both GPS and network information to compute the location. Hybrid-based techniques give the best accuracy of the two but inherit the limitations and challenges of network-based and handset-based technologies.

##### C.1.1 Location accuracy techniques

The following are the location techniques:

- Cell Id
- Cell Id +TA/ Cell ID+RTT
- Enhanced Cell ID (ECID)
- RF Pattern Matching
- U-TDOA (LMU) based
- O-TDOA
- A-GPS
- Mix of one or more of above.

##### C.1.1.1 Cell ID

- a) In this positioning mechanism, the serving cell of the target UE is translated to a geographical shape. This is a quick but low accuracy positioning mechanism. For this the positioning entity needs to have a database of Computer-Generated Imagery (CGI) and the corresponding radio coverage.
- b) Where can be deployed: Cell ID can be implemented regardless of technology.
- c) Salient points:
  - i) Limited accuracy
  - ii) No additional major deployment in network
  - iii) Works in all network technologies (GSM, WCDMA, LTE).

### C.1.1.2 Cell Id +TA/ Cell ID+RTT

- a) The TA is based on the existing Timing Advance (TA) parameter. The TA value is known for the serving BTS. To obtain TA values in case the MS is in idle mode a special call, not noticed by the GSM subscriber (no ringing tone), is set up. The cell-ID of the serving cell and the TA which is received is then used to determine the approximate distance of the UE from the tower.

The Round Trip Time (RTT) measures the distance between the WCDMA-handset and the base station, i.e. with a similar purpose as TA in GSM. Accuracy depends upon various factors such as inter site distance, accuracy of Cell site data bases and stability in RF characteristics of the network. Works with WCDMA network.

- b) Salient points:
- i) Cell Id + TA/ Cell Id + RTT positioning method is merely an enhancement of the Cell Id.
  - ii) The TA parameter is an estimate of the distance (in increments of 550 M) from the mobile terminal to the base station.
  - iii) The RTT measures the distance between the WCDMA-handset and the base station, i.e. with a similar purpose as TA in GSM.
  - iv) Works in all network technologies.

### C.1.1.3 E-CID {(Cell Id+TA)/(Cell ID+RTT) & NMR}

- a) Network Management Reports (NMR) like power measurement can also be used to enhance accuracy of RTT and CGI.

- b) Salient points:
- i) Medium accuracy around 200 metres in urban areas depending upon inter site distance and number of neighbours.
  - ii) Works in all network technologies.

### C.1.1.4 RF Pattern Printing (RFPM)

Radio Frequency Pattern Printing (RFPM) is a positioning method that uses the RF patterns observed in the region to determine UE location using the NMRs as main inputs. RFPM compares “fingerprint” data received from the handsets with the database of radio frequency strength of the same area. This will improve accuracy considerably. Accuracy depends upon various factors such as inter site distance, accuracy of Cell site data bases and stability in RF characteristics of the network. RFPM works with GSM and WCDMA networks.

- a) RF Profiling/Pattern Matching/Fingerprinting- The technology is capable of meeting the 100 m/300 m requirement for network-based solutions in many urban and some dense suburban settings. Accuracy in urban, suburban/rural areas may be achieved depending upon inter site distance and number of neighbours.
- b) Works in all network technologies.
- c) RF fingerprinting requirements:
- i) The method requires periodic drive tests and collection of data over the required area. The samples are to be collected at different point of time in a day or adaption of RF patterns data for different RF characteristics in a day.
  - ii) Large number of samples with the required parameters to be taken.
  - iii) The drive test for in building and hand held drive test for congested locations (which are non-drivable) should also be done and integrated with the drive test of outdoor to generate RF pattern data.
  - iv) Incremental drive test or tuning of RF measurement pattern is required in case of change in antenna power, tilt or beam width or when a new base station is installed or any base station stops radiating, the topology changes due to change in Landscape, infrastructure development, terrain, etc.

### C.1.1.5 Uplink time duration of arrival (UTDOA) – Location management unit (LMU)

- a) This is software and hardware based solution to be installed along with an existing BTS. It will require backend infrastructure to collect process and present the required information.
- b) The technology is capable of meeting the 100 m/300 m requirement for network-based solutions. Higher accuracy in urban, suburban/rural areas may be achieved depending upon inter site distance and number of neighbours.
- c) Will require additional O&M of LMU hardware.
- d) Works in GSM.
- e) LMU requirements:
  - i) At least two neighbours are required.
  - ii) For synchronization, GPS infrastructure (GPS antenna, cable) is required.
  - iii) Signalling connectivity between LMU Server and LMUs (located at BTS) is required.
  - iv) It is an active element which requires connectivity at BTS.

### C.1.1.6 Observed time duration of arrival (O-TDOA)

- a) To be deployed for LTE.
- b) O-TDOA is a downlink trilateration technique that requires the User Equipment (UE) to detect at least two neighbour eNodeBs.
- c) The UE requires O-TDOA software support in order to process the signals from multiple eNodeBs and interact with the E-SMLC/SLP (Evolved Serving Mobile Location Centre / SUPL Location Platform) server.

### C.1.1.7 A-GPS

GPS is a satellite based positioning technology. In this UE calculated its location and provides it to the network. A variant of GPS is A-GPS wherein network provides initial assistance data to the UE to reduce the location determination time. GPS based mechanism generally does not work as well indoors or in areas where clear sky is not visible.

- a) Salient points:
  - i) Good accuracy in Sub-urban/ Rural/Remote. In strong signal conditions (e.g. rural environment with user in clear sky conditions), the accuracy can be better than 10 m. In some dense urban or indoors environments, accuracy may degrade to the 50-100 m range.
  - ii) Only works for users with GPS on their handsets.
  - iii) GPS enabling is user controlled.

### C.1.2 Factors impacting location accuracy

In all location accuracy a method except A-GPS, the accuracy is dependent on inter site distance and number of neighbours of BTSs. Lower the inter site distance the accuracy shall be higher.

Also higher the number of neighbours the accuracy shall be higher.

### C.1.3 Required features and issues in supporting LBS

- a) Location nodes i.e. GMLC (Gateway Mobile Location Centre), SMLC (Serving Mobile Location Centre) and its associated interfaces are required.
- b) The following are the requirements in various network elements for LBS support:
  - i) BSC/RNC:
    - Lb/Iupc Interface on every BSC/RNC
    - Network features required in each BSC/RNC
    - Unique Point Code/GT/RNCID in all BSCs/RNCs across all PLMNs

- BSC/RNC Reachability – STP (Signalling Transfer Point) or Direct?
  - Full CGI (Cell Global Identifier) Value (MCC+MNC+LAC+CI) to be provided by BSCs
  - Full CGI Value (MCC+MNC+LAC/RNCID+CID) to be provided by RNCs
  - Extra Load on BSC/RNC for All Call CDR (Call-detail Record) Requirement.
- ii) MSC/MME:
- Lg/SLg & SLs Interface on every MSC/MME
  - Network features required in each MSC/MME.
- iii) HLR/HSS:
- Lh/SLh Interface on every HLR/HSS
  - Network features required in each HLR/HSS.
- iv) BTS/Node B/E-Node B:
- Intersite Distance Requirement. Accuracy shall increase with lesser inter-site distance and more number of neighbours for network based solutions.
- c) As the usage of location based services increases, it will have impact on different network elements and signalling etc. for which re-dimensioning of various network elements may be required.



## ANNEX D

### Description of wireless backhaul systems

- Recommendation ITU-R F.385 – Radio-frequency channel arrangements for fixed wireless systems operating in the 7 110-7 900 MHz band
- Recommendation ITU-R F.386 – Radio-frequency channel arrangements for fixed wireless systems operating in the 8 GHz (7 725 to 8 500 MHz) band
- Recommendation ITU-R F.387 – Radio-frequency channel arrangements for fixed wireless systems operating in the 10.7-11.7 GHz band
- Recommendation ITU-R F.497 – Radio-frequency channel arrangements for fixed wireless systems operating in the 13 GHz (12.75-13.25 GHz) frequency band
- Recommendation ITU-R F.595 – Radio-frequency channel arrangements for fixed wireless systems operating in the 17.7-19.7 GHz frequency band
- Recommendation ITU-R F.636 – Radio-frequency channel arrangements for fixed wireless systems operating in the 14.4-15.35 GHz band
- Recommendation ITU-R F.637 – Radio-frequency channel arrangements for fixed wireless systems operating in the 21.2-23.6 GHz band
- Recommendation ITU-R F.746 – Radio-frequency arrangements for fixed service systems
- Recommendation ITU-R F.747 – Radio-frequency channel arrangements for fixed wireless system operating in the 10.0-10.68 GHz band
- Recommendation ITU-R F.748 – Radio-frequency arrangements for systems of the fixed service operating in the 25, 26 and 28 GHz bands
- Recommendation ITU-R F.749 – Radio-frequency arrangements for systems of the fixed service operating in sub-bands in the 36-40.5 GHz band
- Recommendation ITU-R F.752 – Diversity techniques for point-to-point fixed wireless systems
- Recommendation ITU-R F.755 – Point-to-multipoint systems in the fixed service
- Recommendation ITU-R F.758 – System parameters and considerations in the development of criteria for sharing or compatibility between digital fixed wireless systems in the fixed service and systems in other services and other sources of interference
- Recommendation ITU-R F.1093 – Effects of multipath propagation on the design and operation of line-of-sight digital fixed wireless systems
- Recommendation ITU-R F.1101 – Characteristics of digital fixed wireless systems below about 17 GHz
- Recommendation ITU-R F.1102 – Characteristics of fixed wireless systems operating in frequency bands above about 17 GHz
- Recommendation ITU-R F.1336 – Reference radiation patterns of omnidirectional, sectoral and other antennas for the fixed and mobile service for use in sharing studies in the frequency range from 400 MHz to about 70 GHz
- Recommendation ITU-R F.1494 – Interference criteria to protect the fixed service from time varying aggregate interference from other services sharing the 10.7-12.75 GHz band on a co-primary basis
- Recommendation ITU-R F.1495 – Interference criteria to protect the fixed service from time varying aggregate interference from other radiocommunication services sharing the 17.7-19.3 GHz band on a co-primary basis

- Recommendation ITU-R F.1496 – Radio-frequency channel arrangements for fixed wireless systems operating in the band 51.4-52.6 GHz
- Recommendation ITU-R F.1497 – Radio-frequency channel arrangements for fixed wireless systems operating in the band 55.78-66 GHz
- Recommendation ITU-R F.1520 – Radio-frequency arrangements for systems in the fixed service operating in the band 31.8-33.4 GHz
- Recommendation ITU-R F.1565 – Performance degradation due to interference from other services sharing the same frequency bands on a co-primary basis, or from other sources of interference, with real digital fixed wireless systems used in the international and national portions of a 27 500 km hypothetical reference path at or above the primary rate
- Recommendation ITU-R F.1606 – Interference criteria to protect fixed wireless systems from time varying aggregate interference produced by non-geostationary satellites operating in other services sharing the 37-40 GHz and 40.5-42.5 GHz bands on a co-primary basis
- Recommendation ITU-R F.1668 – Error performance objectives for real digital fixed wireless links used in 27 500 km hypothetical reference paths and connections
- Recommendation ITU-R F.1669 – Interference criteria of fixed wireless systems operating in the 37-40 GHz and 40.5-42.5 GHz bands with respect to satellites in the geostationary orbit
- Recommendation ITU-R F.1703 – Availability objectives for real digital fixed wireless links used in 27 500 km hypothetical reference paths and connections
- Recommendation ITU-R F.2004 – Radio-frequency channel arrangements for fixed service systems operating in the 92-95 GHz range
- Recommendation ITU-R F.2005 – Radio-frequency channel and block arrangements for fixed wireless systems operating in the 42 GHz (40.5 to 43.5 GHz) band
- Recommendation ITU-R F.2006 – Radio-frequency channel and block arrangements for fixed wireless systems operating in the 71-76 and 81-86 GHz bands
- Recommendation ITU-R P.525 – Calculation of free-space attenuation
- Recommendation ITU-R P.530 – Propagation data and prediction methods required for the design of terrestrial line-of-sight systems
- Recommendation ITU-R P.581 – The concept of "worst month"
- Recommendation ITU-R P.676 – Attenuation by atmospheric gases and related effects
- Recommendation ITU-R P.837 – Characteristics of precipitation for propagation modelling
- Recommendation ITU-R P.841 – Conversion of annual statistics to worst-month statistics
- Recommendation ITU-R SM.329 – Unwanted emissions in the spurious domain
- Recommendation ITU-R SM.853 – Necessary bandwidth
- Recommendation ITU-R SM.1541 – Unwanted emissions in the out-of-band domain

## ANNEX E

### Description of external organizations

#### E.1 3GPP

The 3<sup>rd</sup> Generation Partnership Project (3GPP) unites seven telecommunications standard development organizations (ARIB, ATIS, CCSA, ETSI, TSDSI, TTA and TTC), referred to as “Organizational Partners” and provides members with an independent and stable environment to produce the Reports and Specifications that specify and define 3GPP technologies. The work conducted within the 3GPP focuses on specific projects and studies aimed at the evolution and improvement of the standards that serve as the basis for the global cellular mobile industry.

The project covers cellular telecommunications network technologies, including radio access, the core transport network, and service capabilities – including work on codecs, security and quality of service. It thus provides complete system specifications. The specifications also provide hooks for non-radio access to the core network, and for interworking with Wi-Fi networks.

3GPP specifications and studies are contribution-driven, by member companies, in Working Groups and at the Technical Specification Group level.

For more information please refer to <http://www.3gpp.org/about-3gpp/about-3gpp>

#### E.2 3GPP2

The Third Generation Partnership Project 2 (3GPP2) is a collaborative third generation telecommunications specifications-setting project comprising North American and Asian interests developing global specifications for ANSI/TIA/EIA-41 (MC\_CDMA/cdma2000) Cellular Radio telecommunication Intersystem Operations network evolution to IMT-2000 and global specifications for the radio transmission technologies (RTTs) supported by ANSI/TIA/EIA-41.

3GPP2 was born out of the International Telecommunication Union’s (ITU) International Mobile Telecommunications “IMT-2000” initiative.

#### E.3 IEEE

The IEEE Standards Association (IEEE-SA), a globally recognized standards-setting body within IEEE, develops consensus standards through an open process that engages industry and brings together a broad stakeholder community. IEEE standards set specifications and best practices based on current scientific and technological knowledge. The IEEE-SA has a portfolio of over 900 active standards and more than 500 standards under development.

The IEEE 802 LAN/MAN Standards Committee develops and maintains networking standards and recommended practices for local, metropolitan, and other area networks, using an open and accredited process, and advocates them on a global basis. The most widely used standards are for Ethernet, Bridging and Virtual Bridged LANs Wireless LAN, Wireless PAN, Wireless MAN, Wireless Coexistence, Media Independent Handover Services, and Wireless RAN. These standards are published by the IEEE Standards Association (IEEE-SA) of the Institute of Electrical and Electronics Engineers (IEEE). An individual Working Group provides the focus for each area.

The IEEE standards relevant for IMT-2000 OFDMA TDD WMAN, designated as IEEE Std 802.16 and IEEE Std 802.16.1, are developed and maintained by the IEEE 802.16 Working Group on Broadband Wireless Access.

## ANNEX F

## Published Recommendations, Reports and ongoing activities of ITU-R on terrestrial IMT

### Content:

- F.1 Overview of Recommendations and Reports of ITU-R related to Terrestrial IMT
- F.2 Published Recommendations and Reports of ITU-R related to Terrestrial IMT
- F.3 Work ongoing and underway in ITU-R WP5D
- F.4 All list of ITU-R Recommendations and Reports on IMT

### **F.1 Overview of Recommendations and Reports of ITU-R related to terrestrial IMT**

#### **F.1.1 General IMT**

The various terms and definitions that are considered essential to the understanding and application of the principles of IMT are included in Recommendation ITU-R M.1224.

In 1986, the ITU began work on developing a global future public land mobile telecommunications system (FPLMTS), which in 1994 was re-named IMT-2000 (International Mobile Telecommunications-2000). Objectives were defined initially for IMT-2000 and subsequently for each new generation approximately every 10 years.

Report ITU-R M.1153 describes the general objectives, suitable frequency bands and the degrees of compatibility of the FPLMTS.

Recommendation ITU-R M.687 defines the objectives to be met by IMT-2000 and provides the overall IMT-2000 concepts with particular consideration to achieving worldwide roaming and compatibility. Recommendation ITU-R M.1645 defines the framework and overall objectives of the future development of IMT-2000 and systems beyond IMT-2000 for the radio access network (IMT-Advanced).

Recommendation ITU-R M.2083 establishes the objectives for IMT for 2020 and beyond, by describing potential user and application directions, growth in traffic, technological evolution and spectrum implications, and by providing guidelines on the framework and the capabilities for IMT for 2020 and beyond. Envisaged three usage scenarios for IMT-2020:

- Enhanced mobile broadband (eMBB).
- Ultra-reliable and low-latency communications (URLLC).
- Massive machine-type communications (mMTC).

#### **F.1.2 Framework of services supported by IMT**

Recommendation ITU-R M.816 forms a framework for continued development towards detailed IMT-2000 service descriptions. It includes those services supported by user bit rates up to approximately 2 Mbit/s as well as new services, some of which may require higher bit rates.

Recommendation ITU-R M.1822 addresses high-level requirements for telecommunication services and applications to be supported by IMT, including the future development of IMT-2000 and IMT-Advanced. The recommendation also includes service parameters and service classifications of IMT, and service examples that may be supported by IMT.

### **F.1.3 Specific applications**

Public protection and disaster relief (PPDR) is defined in Resolution **646 (Rev.WRC-19)** and Report ITU-R M.2291 addresses the current and possible future use of IMT including the use of Long Term Evolution (LTE) in support of broadband PPDR communications.

Report ITU-R M.2373 – Audio-visual capabilities and applications supported by terrestrial IMT systems, examines the capabilities of IMT systems to deliver audio-visual services to consumers.

Report ITU-R M.2440 addresses the technical and operational aspects of terrestrial IMT-based radio networks and systems supporting machine type communication (MTC) applications, as well as spectrum needed, including possible harmonized use of spectrum to support the implementation of narrowband and broadband MTC infrastructure and devices.

Report ITU-R M.2441 – Emerging usage of the terrestrial component of International Mobile Telecommunication (IMT), provides information on the usage of IMT systems for emerging use cases or applications such as Intelligent Transport Systems (ITS), railways or high-speed train communications, industrial automation, remote control, etc.

### **F.1.4 Performance/QoS**

Recommendation ITU-R M.1079 defines the speech/data quality and performance requirements for IMT-2000 access networks taking into consideration the end-to-end requirements. It also defines the connection/session performance, concerning issues such as call set-up time, delay characteristics and handover probability, to be achieved in the IMT-2000 access network that the user will expect in a network of comparable performance to the fixed network.

### **F.1.5 Developing countries**

Recommendation ITU-R M.819 describes the objectives to be met by IMT-2000 to meet the needs of developing countries. The potential of mobile radio technologies, including IMT-2000, to help developing countries “bridge the gap” between their communication capabilities and those in developed countries.

Report ITU-R M.1155 emphasizes the needs and interests of developing countries by promoting the applications of FPLMTS for fixed services (FS). It is also stressed that the use of FPLMTS for such applications is also attractive to developed countries.

### **F.1.6 IMT-2000**

Recommendation ITU-R M.1034 builds on the IMT-2000 concepts and to provide a high-level view of the constraints placed on the radio interface(s) particularly in terms of the system requirements, user requirements, and operational requirements.

Recommendation ITU-R M.1225 provides guidelines for both the procedure and the criteria to be used in evaluating radio transmission technologies (RTTs) for a number of test environments. These test environments, defined in the recommendation, are chosen to simulate closely the more stringent radio operating environments.

### **F.1.7 IMT-Advanced**

Resolution ITU-R 57 contains the principles for the process of development of IMT-Advanced.

Report ITU-R M.2133 addresses the requirements, evaluation criteria, as well as submission templates required for a complete submission of candidate radio interface technologies (RITs) and candidate sets of radio interface technologies (SRITs) for IMT-Advanced.

Report ITU-R M.2134 – Requirements related to technical system performance for IMT-Advanced radio interface(s), describes requirements related to technical performance for IMT-Advanced candidate RITs and also provides the necessary background information about the individual requirements and the justification for the items and values chosen.

Report ITU-R M.2135 provides guidelines for both the procedure and the criteria (technical, spectrum and service) to be used in evaluating the candidate IMT-Advanced RITs or SRITs for a number of test

environments and deployment scenarios for evaluation. The evaluation procedure is designed in such a way that the overall performance of a candidate RIT/SRIT is fairly and consistently assessed on a technical basis.

Report ITU-R M.2198 is the record of the work performed after receipt of the proposals for IMT-Advanced candidate RITs and SRITs, including the evaluation activity and the consensus building.

### F.1.8 IMT-2020

As defined in Resolution ITU-R 56, IMT-2020 systems are mobile systems that include new radio interface(s) which support the new capabilities of systems beyond IMT-2000 and IMT-Advanced. The intention is to make IMT-2020 more flexible, reliable and secure than previous IMT when providing diverse services in the intended three usage scenarios, including eMBB, URLLC and mMTC.

Resolution ITU-R 65 provides the principles for the process of future development of IMT for 2020 and beyond.

Report ITU-R M.2410 describes key requirements related to the minimum technical performance of IMT-2020 candidate RITs. It also provides the necessary background information about the individual requirements and the justification for the items and values chosen.

Report ITU-R M.2411 addresses the requirements, evaluation criteria, as well as submission templates required for a complete submission of RITs and SRITs for IMT-2020.

Report ITU-R M.2412 provides guidelines for the procedure, the methodology and the criteria (technical, spectrum and service) to be used in evaluating the candidate IMT-2020 RITs or SRITs for a number of test environments. These test environments are chosen to simulate closely the more stringent radio operating environments. The evaluation procedure is designed in such a way that the overall performance of the candidate RITs/SRITs may be fairly and equally assessed on a technical basis.

Report ITU-R M.2483 is the results record of the work performed after reception of the RIT and SRIT proposals for IMT-2020, including the evaluation activity, the consensus building, the outcome and the conclusions. Report ITU-R M.2498 is the record of the work performed after receipt of complete proposals for IMT-2020 candidate “DECT-2020 NR” component RIT and “3GPP 5G NR” component RIT.

### F.1.9 IMT process

The ITU-R Recommendations and Reports that have been published in support of the IMT process for the various generations of IMT are summarized in below.

TABLE 2

	IMT-2000	IMT-Advanced	IMT-2020
<b>Objectives</b>	M.687 (1990-1992-1997) <sup>(1)</sup>	M.1645 (2003) <sup>(1)</sup>	M.2083 (2015) <sup>(1)</sup>
<b>Requirements</b>	M.1034 (1994-1997) <sup>(1)</sup>	M.2134 (2008) <sup>(2)</sup> M.2133 (2008) <sup>(2)</sup>	M.2410 (2017) <sup>(2)</sup> M.2411 (2017) <sup>(2)</sup>
<b>Submission C.L.</b>	8/LCCE/47 (1997) <sup>(3)</sup>	5/LCCE/2 (2008) <sup>(3)</sup>	5/LCCE/59 (2016) <sup>(3)</sup>
<b>Evaluation</b>	M.1225 (1997) <sup>(1)</sup>	M.2135 (2008-2009) <sup>(2)</sup>	M.2412 (2017) <sup>(2)</sup>
<b>Outcome</b>	M.1455 (suppressed) <sup>(1)</sup>	M.2198 (2010) <sup>(2)</sup>	M.2483 (2020) <sup>(2)</sup> M.2498 (2021) <sup>(2)</sup>
<b>Specifications</b>	M.1457 (2000-...-2020) <sup>(1)</sup>	M.2012 (2012-...-2022) <sup>(1)</sup>	M.2150 (2022) <sup>(1)</sup>

<sup>(1)</sup> ITU-R Recommendation.

<sup>(2)</sup> ITU-R Report.

<sup>(3)</sup> C.L.: Circular Letter inviting the submission of candidate technologies.

*Note:* The years in brackets indicate the approval of the various revisions.

### F.1.10 Architecture

Recommendation ITU-R M.817 presents the functional network architectures and some of the resulting network configurations which are possible for IMT-2000.

Report ITU-R M.2375 describes an overview of the architecture, topology/configuration, and transport requirements of IMT networks.

In order to specify the radio interface(s) of IMT-2000, Recommendation ITU-R M.1035 presents an overview of the radio subsystem for IMT-2000 and give guidelines for the development of the structure of the radio sub-system. The radio sub-system includes the functionalities needed to provide IMT-2000 services over a radio interface(s) to mobile terminals in all IMT-2000 operating environments. Recommendation ITU-R M.1311 identifies and describes the modularity and radio commonality principles which should be adopted in the development of the radio-related aspects of IMT-2000.

Recommendation ITU-R M.1182 provides five levels of different architecture for the integration of mobile-satellite service (MSS) systems with terrestrial PSTN or cellular network.

### F.1.11 Radio interface specifications

Table 3 contains the ITU-R Recommendations that have been published with the specifications of each generation of IMT.

TABLE 3

IMT Generation	Specifications
IMT-2000	Recommendation ITU-R M.1457
IMT-Advanced	Recommendation ITU-R M.2012
IMT-2020	Recommendation ITU-R M.2150

### F.1.12 Unwanted emissions

Recommendation ITU-R M.1580 provides the generic unwanted emission characteristics of base stations using the terrestrial radio interfaces of IMT-2000.

Recommendation ITU-R M.1581 provides the generic unwanted emission characteristics of mobile stations using the terrestrial radio interfaces of IMT-2000, suitable for establishing the technical basis for global circulation of IMT-2000 terminals.

Recommendation ITU-R M.2070 provides the generic unwanted emission characteristics of base stations using the terrestrial radio interfaces of IMT-Advanced.

Recommendation ITU-R M.2071 provides the generic unwanted emission characteristics of mobile stations using the terrestrial radio interfaces of IMT-Advanced, suitable for establishing the technical basis for global circulation of IMT-Advanced terminals.

TABLE 4

IMT radio interface	Generic unwanted emission characteristics	
	Base station	Mobile station
IMT-2000	Rec. ITU-R M.1580	Rec. ITU-R M.1581
IMT-Advanced	Rec. ITU-R M.2070	Rec. ITU-R M.2071



Table 4 above contains the ITU-R Recommendations that have been published with the generic unwanted emissions characteristics of each IMT radio interface generation for base and mobile stations.

### **F.1.13 Frequency spectrum needs**

Spectrum requirements for the terrestrial component of IMT-2000 were estimated prior to World Administrative Radio Conference in 1992 (WARC-92). These spectrum calculations are documented in Recommendation ITU-R M.687. As technology advances, customers will demand more and more capabilities from wireless services. As a result, this section contains all the studies on estimated spectrum and traffic requirements for the future development of IMT.

### **F.1.14 Estimation methodologies**

ITU-R has developed methodologies for the estimation of required terrestrial spectrum which are defined in:

- Recommendation ITU-R M.1390 contains a methodology for the calculation of terrestrial spectrum requirement estimates for IMT-2000. This methodology could also be used for other public land mobile radio systems. It provides a systematic approach that incorporates geographic influences, market and traffic impacts, technical and system aspects and consolidation of spectrum requirement results.
- Recommendation ITU-R M.1768 describes a methodology for the calculation of terrestrial spectrum requirement estimation for IMT. It provides a systematic approach that incorporates service categories (a combination of service type and traffic class), service environments (a combination of service usage pattern and teledensity), radio environments, market data analysis and traffic estimation by using these categories and environments, traffic distribution among radio access technique groups (RATGs), required system capacity calculation and resultant spectrum requirement determination. Report ITU-R M.2289 presents the future radio aspect parameters for use with the terrestrial IMT spectrum estimate methodology of Recommendation ITU-R M.1768 in conjunction with developing the future spectrum requirement estimate for terrestrial IMT systems, principally focused towards the years 2020 and beyond.

### **F.1.15 Frequency spectrum needs**

Report ITU-R M.2023 determines the amount of spectrum needed to support IMT-2000 services by both the terrestrial and satellite components of IMT-2000. It also describes the forecast demand estimates for such services.

Report ITU-R M.2078 provides results of technical studies on estimated spectrum requirements for the future development of IMT-2000 and for IMT-Advanced.

Since the approval of the previous Report in 2006, there have been significant advances in IMT technologies and the deployment of IMT networks.

Report ITU-R M.2072 provides a summary of the market analysis and forecast of evolution of mobile market and services for the future development of IMT-2000, systems beyond IMT-2000 and other systems. This Report has derived market related parameters and provided forecasts for 2010, 2015, and 2020 for the mobile market, as estimated in the year 2006.

Report ITU-R M.2079 provides useful information for administrations to consider when processing spectrum selection for the future development of IMT-2000 and IMT-Advanced.

ITU-R has developed two documents on traffic, as well as spectrum requirements to 2020, namely:

- Report ITU-R M.2243 reviews both the market and traffic forecasts for IMT that were developed in previous study periods (2000-2007) and assesses the perspectives and future needs of MBB that would be supported by IMT until 2020. In addition, it provides traffic forecasts up to 2015, and in some cases up to 2020, taking into account new market drivers.
- Report ITU-R M.2290 provides a global perspective on the future spectrum requirements estimate for terrestrial IMT. In order to estimate the spectrum requirements for 2020, this Report predicts future traffic growth up to 2020 and derived input parameters representing a possible set of global scenarios of the future mobile traffic growth.

Building on the Reports described above, Report ITU-R M.2370 analyses factors impacting future IMT traffic growth beyond the year 2020 and estimates the traffic demands for the period 2020 to 2030. There are many drivers impacting future IMT traffic growth and the characteristics of the traffic that are envisaged to generate this growth are also described in this Report.

### **F.1.16 Characteristics for sharing studies**

To perform the necessary sharing and compatibility studies between IMT systems and systems in other services, characteristics of the terrestrial component of IMT systems are needed. These characteristics can be found in:

- For IMT-2000, Report ITU-R M.2039 provides the baseline characteristics of terrestrial IMT-2000 systems only for use in frequency sharing and interference analysis studies involving IMT-2000 systems and between IMT-2000 systems and other systems.
- Parameters of IMT-Advanced interface for frequency sharing and interference analysis studies are addressed in Report ITU-R M.2292.

### **F.1.17 Methodologies**

Methodologies to perform the necessary sharing and compatibility studies between IMT systems and systems in other services can be found in:

- Recommendation ITU-R M.1635 provides recommendations for administrations for a methodology for assessing the potential for interference between IMT-2000 and systems beyond and other services under co-frequency as well as adjacent band conditions.
- Recommendation ITU-R M.1641 contains a methodology for evaluating co-channel interference and a separation distance between a high-altitude platform stations (HAPS) system as a base station for IMT-2000 and a terrestrial tower-based cellular system providing IMT-2000 service.
- Recommendation ITU-R M.1654 contains methodology to assess the interference from broadcasting-satellite service (BSS) (sound) into terrestrial IMT-2000 systems intending to use the band 2 630-2 655 MHz and that could be used to determine the impact of BSS (sound) on terrestrial IMT-2000 in the context of co-frequency sharing through the development of power flux-density (pfd) masks, where applicable.
- Recommendation ITU-R M.2101 describes the methodology for modelling and simulation of IMT networks for use in sharing and compatibility studies between IMT and other systems and/or applications.
- Recommendation ITU-R M.1545 describes the application of measurement uncertainty to test limits when devices for terrestrial component of IMT-2000 are tested for conformance.

### **F.1.18 Sharing studies**

In this section, all frequency sharing studies and interference analyses involving IMT systems and other systems and services operating in bands identified for IMT are listed. The following ones are in force:

- Report ITU-R M.2110 assesses the feasibility of sharing between IMT systems operating in the 450-470 MHz band and the radiocommunication services having a primary allocation.
- Report ITU-R F.2331 examines the compatibility of proposed IMT systems and FS systems operating in the 470-694/698 MHz frequency range.
- Recommendation ITU-R M.2090 provides guidance to administrations on specific unwanted emission levels of IMT mobile stations operating in the frequency band 694-790 MHz in order to facilitate protection of existing services in the frequency band 470-694 MHz in Region 1.
- Report ITU-R BT.2337 provides sharing and compatibility studies were conducted between terrestrial mobile broadband applications, including IMT, and digital terrestrial television broadcasting (DTTB) in the frequency band 470-694 MHz in the GE06 planning area.
- Report ITU-R BT.2338 provides relevant information on audio SAB/SAP, including technical characteristics, quality requirements, current spectrum use, and the impact of the loss of the 694-790 MHz band.

- Report ITU-R BT.2339 describes co-channel sharing and compatibility studies between digital terrestrial television broadcasting and IMT in the frequency band 694-790 MHz in the GE06 planning area.
- Report ITU-R M.2241 provides sharing study results in relation with Resolution **224 (Rev.WRC-19)**. It assesses the degree of compatibility between IMT systems operating in the frequency bands 790-862 MHz or 698-806 MHz and systems of other services operating in the same or adjacent band.
- Report ITU-R RS.2336 provides analyses based on both static scenario and dynamic methodology to address the compatibility between IMT systems in the frequency bands 1 375-1 400 MHz and 1 427-1 452 MHz and Earth exploration-satellite service (EESS) (passive) systems in the 1 400-1 427 MHz frequency band.
- Report ITU-R F.2333 presents an analysis of the feasibility of co-channel compatibility/sharing between IMT systems and FS point-to-point links currently operating in the frequency band 1 350-1 527 MHz.
- Report ITU-R BS.2340 provides a sharing study between potential IMT systems and the broadcasting service (BS) in the frequency band 1 452-1 492 MHz.
- Report ITU-R M.2324 provides sharing studies between potential IMT systems and aeronautical mobile telemetry (AMT) systems in the frequency band 1 429-1 535 MHz.
- Report ITU-R SA.2329 provides an assessment of the separation distance that would be required between IMT stations (base stations and user equipment (UE)) and meteorological-satellite service (MetSat) receiving earth stations in the 1 695-1 710 MHz frequency band.
- Report ITU-R SA.2325 considers the feasibility of LTE type of IMT systems sharing the frequency bands 2 025-2 110 MHz and 2 200-2 290 MHz with incumbent primary services of the space research, Earth exploration-satellite and space operation services in the space-to-space direction.
- Report ITU-R M.2374 provides an un-paired arrangement, time division duplex (TDD) for the band 2 300-2 400 MHz. This band is used or is planned to be used for mobile broadband wireless access (BWA) including IMT technologies in a number of countries and there is a need for a study on coexistence of BWA systems, deployed in the same geographical area, using TDD mode in adjacent spectrum blocks in 2 300-2 400 MHz band in order to maximize the additional benefit from harmonized use of the band.
- Report ITU-R M.2499 addresses the study on the aspects of synchronization operations of multiple IMT-2020 TDD networks in close proximity using the same frequency band, including analyses of coexistence issues when IMT operators utilize different synchronization modes, performance evaluation under different synchronization modes, and coexistence mitigation strategies.
- Report ITU-R M.2041 identifies sharing and adjacent band compatibility in the 2.5 GHz band between the terrestrial and satellite components of IMT-2000.
- Report ITU-R M.2030 addresses the coexistence between IMT-2000 time division duplex and frequency division duplex terrestrial RITs around 2 600 MHz operating in adjacent bands and in the same geographical area.
- Report ITU-R M.2045 considers techniques to improve compatibility between IMT-2000 time division duplex (TDD) and frequency division duplex (FDD) RITs operating in adjacent frequency bands and in the same geographic area within the 2 500-2 690 MHz frequency band.
- Report ITU-R M.2113 focuses on sharing studies in the 2 500-2 690 MHz band between IMT-2000 and fixed broadband wireless access systems including nomadic applications in the same geographical area.
- Report ITU-R M.2146 studies the coexistence between IMT-2000 CDMA-DS and IMT-2000 OFDMA-TDD-WMAN in the 2 500-2 690 MHz band operating in adjacent bands in the same area.

- Recommendation ITU-R M.1646 contains the parameters to be used in co-frequency sharing and pfd threshold studies between terrestrial IMT-2000 and broadcasting-satellite service (sound) in the 2 630-2 655 MHz band.
- Report ITU-R M.2112 provides compatibility analysis between air surveillance radars (ASR) and meteorological radars and IMT systems operating in the 2 700-2 900 MHz band with new assumptions and systems characteristics.
- Report ITU-R M.2481 contains studies on operational measures to enable coexistence of IMT and radiolocation service in the frequency band 3 300-3 400 MHz, and compatibility studies in adjacent bands between IMT systems operating in the frequency band 3 300-3 400 MHz and radiolocation systems operating below 3 300 MHz.
- Report ITU-R M.2111 provides sharing studies between radar systems and IMT-Advanced systems in the bands 3 400-3 700 MHz, and potential interference mitigation techniques.
- Report ITU-R F.2328 examines the compatibility of proposed IMT systems and FS systems operating in the 3 400-4 200 MHz frequency range.
- Report ITU-R M.2109 provides a summary of the sharing studies between IMT-Advanced systems and geostationary satellite networks in the fixed-satellite service (FSS) in the 3 400-4 200 and 4 500-4 800 MHz frequency bands.
- Report ITU-R S.2368 describes sharing studies between IMT-Advanced systems and geostationary satellite networks in the fixed-satellite service in the 3 400-4 200 MHz and 4 500-4 800 MHz frequency bands.
- Report ITU-R F.2327 provides the results of compatibility studies between IMT system and point-to-point fixed wireless systems in the frequency band 4 400-4 990 MHz.
- Report ITU-R S.2367 describes sharing studies between IMT-Advanced systems and satellite networks in the fixed-satellite service in the 5 850-6 425 MHz frequency band.
- Report ITU-R F.2326 addresses the sharing and compatibility study between indoor IMT small cells and FS stations in the 5 925-6 425 MHz frequency band.

To summarize, all sharing and compatibility studies mentioned are referenced in Table 5 below are sorted by the service they are sharing the frequency spectrum with, in each identified IMT band.

TABLE 5

Band (MHz)	IMT frequency spectrum sharing studies											
	Terrestrial services					Satellite services			Science services			
	FS	BS (sound)	BS (television)	LMS	RDS	FSS	BSS	MSS	EESS	SRS	SOS	RAS
450-470	M.2110	M.2110*	M.2110*	M.2110	M.2110 (RLS)			M.2110				
470-698	F.2331		BT.2337									RA.2332
694/698-960	M.2241	M.2241 <i>M.2090*</i>	M.2241 <i>M.2090*</i> BT.2339 BT.2338		M.2241 (ARNS)							
1 427-1 518	F.2333	BS.2340			M.2324 (AMS/AMT)				RS.2336			RA.2332*
1 710-2 025									SA.2329* (MetSat)			RA.2332*
2 110-2 200									SA.2325	SA.2325	SA.2325	
2 300-2 400				M.2374								
2 500-2 690	M.2030 M.2045 M.2113			M.2030 M.2045 M.2146	M.2112* (RLS)		<i>M.1646</i>	M.2041				RA.2332*
3 300-3 400					M.2481 (RLS)							
3 400-3 600	F.2328				M.2111 (RLS)	M.2109 S.2368						
3 600-3 700	F.2328				M.2111 (RLS)	M.2109 S.2368						
4 800-4 990	F.2327 F.2326*					M.2109* S.2368* S.2367*						RA.2332

## Notes:

– Italic font indicates that it is a Recommendation.

\* These sharing studies includes adjacent bands of IMT.

### F.1.19 Frequency implementation

Recommendation ITU-R M.1036 provides guidance on the selection of transmitting and receiving frequency arrangements for the terrestrial component of IMT systems as well as the arrangements themselves, with a view to assisting administrations on spectrum-related technical issues relevant to the implementation and use of the terrestrial component of IMT in the bands identified in the Radio Regulations (RR).

Recommendation ITU-R M.1456 addresses minimum performance characteristics and operational conditions for HAPS operating as IMT-2000 base stations in frequency bands around 2 GHz.

Report ITU-R M.2024 – Summary of spectrum usage survey results, contains the views of a number of administrations that have indicated their current and planned spectrum usage of the bands which are considered potentially suitable for IMT-2000.

### F.1.20 Technology

One of the most challenging aspects of designing future wireless telecommunications systems is accurately anticipating what the future evolution and technological drivers will be. This is made even more difficult by the rapid advances in technology over the last few years and the increasingly sophisticated demands. Therefore, this section contains the existing ITU-R texts about technology in different applications and the future technology evolution.

*Cognitive radio systems (CRS):* Report ITU-R M.2242 addresses aspects of cognitive radio systems specific to IMT systems. It includes results of studies to determine the impact of adding cognitive radio capabilities to existing IMT systems, and analyses the benefits, challenges and impacts of CRSs in IMT, including a description of how the systems would be used in IMT system deployments and their possible impact on the use of IMT frequency spectrum.

*Antennas:* Report ITU-R M.2334 addresses several aspects of active and passive antenna systems for base stations of IMT systems, including:

- the definitions of antenna systems, associated components and terminology;
- definitions for common performance parameters and tolerances;
- guidelines on performance parameters and tolerances;
- and considerations of advanced concepts.

Report ITU-R M.2244 contains methods to estimate the required isolation between IMT base station antennas in the land mobile service that are co-located or located in close proximity and possible antenna orientations to achieve the required isolation.

*Implementation technologies:* Report ITU-R M.2376 provides information on the technical feasibility of IMT in the bands between 6 GHz and 100 GHz. It includes information on how current IMT systems, their evolution, and/or potentially new IMT RITs and system approaches could be appropriate for operation in the bands between 6 GHz and 100 GHz, taking into account the impact of the propagation characteristics related to the possible future operation of IMT in those bands.

Report ITU-R M.2038 – Technology trends, addresses technology topics that appear relevant to some lesser or greater degree to the future development of IMT-2000 and systems beyond IMT-2000. Specifically, it considers these topics in three broad categories:

- technologies which have an impact on spectrum, its utilization and/or efficiency in this context;
- technologies which relate to access networks and radio interfaces;
- technologies which relate to mobile terminals.

Report ITU-R M.2074 describes technical matters related to radio aspects such as requirement for technical characteristics that are needed for the spectrum requirements calculations, values of the required radio parameters, spectrum efficiency values, and suitable spectrum range preference from a technical aspect. These matters are reflected in the process to calculate the required spectrum and to determine suitable frequency ranges for the future development of IMT-2000 and systems beyond IMT-2000 from 2010 onwards.

Considering the timeframe 2015-2020 and beyond, Report ITU-R M.2320 provides a broad view of future technical aspects of terrestrial IMT systems. It includes information on technical and operational characteristics of IMT systems, including the evolution of IMT through advances in technology and spectrally efficient techniques, and their deployment.

More information on this topic can be found in this Handbook, which provides the general information such as service requirements, applications, system characteristics, and substantive information on spectrum, regulatory issues, guideline for the evolution and migration, and core network evolution on IMT.

### **F.1.21 Implementation**

This section provides information on various aspects that need to be considered when planning to use or deploy an IMT. A number of considerations have been identified for the implementation of IMT:

Recommendations and guidance for the evolution of pre-IMT-2000 systems towards IMT-2000 are provided in Recommendation ITU-R M.1308 and Volume 2 of the Land Mobile Handbook.

Recommendation ITU-R M.1168 present the conceptual and methodological framework for the definition of the management of IMT-2000. The methodology described in Recommendation ITU-T M.3020 is used to define management requirements, management services, management functions, information models, and management protocols related to the management of IMT-2000.

Recommendation ITU-R M.1579 establishes the technical basis for global circulation of IMT terrestrial terminals based on terminals not causing harmful interference in any country where they circulate:

- by conforming to IMT-2000 and IMT-Advanced terrestrial radio interface specifications; and
- by complying with unwanted emission limits for IMT-2000 and IMT-Advanced terrestrial radio interfaces.

Report ITU-R M.2480 provides national approaches taken and/or knowledge gained by certain countries wishing to share their approaches, in the use/deployment or planning of terrestrial component of IMT in certain frequency bands that are allocated to the mobile service and identified for IMT, which includes regulatory, technical and operational aspects.

Due to the particular nature of wireless communications, IMT needs to incorporate security measures to prevent unauthorized reception. The IMT radio specifications include the necessary security measures.

Recommendation ITU-R M.1078 provides the principles and framework for the security provided by IMT-2000. The Recommendation covers all aspects of security for IMT-2000 and is intended as a basis for more detailed aspects of IMT-2000 security to be integrated in various ITU-R or ITU-T Recommendations including IMT-2000 requirements at a later stage.

Recommendation ITU-R M.1223 identifies classes of security mechanisms appropriate for implementing the IMT-2000 security features defined in the previous Recommendation on security principles for IMT-2000, and thus for satisfying the IMT-2000 security requirements identified in the same Recommendation.

## F.2 Published Recommendations and Reports of ITU-R related to terrestrial IMT

The following Table includes all IMT related documents sorted by topic<sup>55</sup>.

Type	Series	Number	Rev.	Title	Year	Relevant topic(s)
Rec.	M.	817	0	International Mobile Telecommunications-2000 (IMT-2000) – Network architectures	1992	Architecture IMT-2000
Rec.	M.	1035	0	Framework for the radio interface(s) and radio sub-system functionality for International Mobile Telecommunications-2000 (IMT-2000)	1994	Architecture IMT-2000
Rec.	M.	1182	1	Integration of terrestrial and satellite mobile communication systems	2003	Architecture
Rec.	M.	1311	0	Framework for modularity and radio commonality within IMT-2000	1997	Architecture IMT-2000
Rep.	M.	2375	0	Architecture and topology of IMT networks	2015	Architecture
Rec.	M.	819	2	International Mobile Telecommunications-2000 (IMT-2000) for developing countries	1997	Developing countries IMT-2000
Rep.	M.	1155	0	Adaptation of mobile radiocommunication technology to the needs of developing countries	1990	Developing countries
Rec.	M.	1224	1	Vocabulary of terms for International Mobile Telecommunications (IMT)	2012	Vocabulary
Rec.	M.	1034	1	Requirements for the radio interface(s) for International Mobile Telecommunications-2000 (IMT-2000)	1997	IMT Process IMT-2000
Rec.	M.	1225	0	Guidelines for evaluation of radio transmission technologies for IMT-2000	1997	IMT Process IMT-2000
Rep.	M.	2133	0	Requirements, evaluation criteria and submission templates for the development of IMT-Advanced	2008	IMT Process IMT-Advanced
Rep.	M.	2134	0	Requirements related to technical performance for IMT-Advanced radio interface(s)	2008	IMT Process IMT-Advanced
Rep.	M.	2135	1	Guidelines for evaluation of radio interface technologies for IMT-Advanced	2009	IMT Process IMT-Advanced
Rep.	M.	2198	0	The outcome of the evaluation, consensus building and decision of the IMT-Advanced process (steps 4-7), including characteristics of IMT-Advanced radio interfaces	2010	IMT Process IMT-Advanced
Rep.	M.	2410	0	Minimum requirements related to technical performance for IMT-2020 radio interface(s)	2017	IMT Process IMT-2020
Rep.	M.	2411	0	Requirements, evaluation criteria and submission templates for the development of IMT-2020	2017	IMT Process IMT-2020
Rep.	M.	2412	0	Guidelines for evaluation of radio interface technologies for IMT-2020	2017	IMT Process IMT-2020
Rep.	M.	2483	0	The outcome of the evaluation, consensus building and decision of the IMT-2020 process (Steps 4 to 7), including characteristics of IMT-2020 radio interfaces	2020	IMT Process IMT-2020

<sup>55</sup> The electronic version of this Table can be sorted by columns as required.



Type	Series	Number	Rev.	Title	Year	Relevant topic(s)
Rep.	M.	2498	0	The outcome of "Way Forward Option 2 for "ETSI (TC DECT) and DECT Forum Proponent" of the evaluation, consensus building and decision of the IMT-2020 process (Steps 4 to 7), including characteristics of IMT-2020 radio interfaces	2021	IMT Process IMT-2020
Rec.	M.	1168	0	Framework of International Mobile Telecommunications-2000 (IMT-2000)	1995	Implementation IMT-2000
Rec.	M.	1308	0	Evolution of land mobile systems towards IMT-2000 <i>Note: Responsibility WP5A</i>	1997	Implementation IMT-2000
Rec.	M.	1579	2	Global circulation of IMT terrestrial terminals	2015	Implementation
Rep.	M.	2480	1	National approaches of some countries on the implementation of terrestrial IMT systems in bands identified for IMT	2021	Implementation
Handbook		30	0	Land Mobile (including Wireless Access) – Volume 2: Principles and Approaches on Evolution to IMT-2000/FPLMTS	1997	Implementation IMT-2000
Handbook		37	0	IMT-2000: Special Edition	2000	Implementation IMT-2000
Handbook		46	1	Migration to IMT-2000 Systems – Supplement 1 (Revision 1) of the Handbook on Deployment of IMT-2000 Systems	2011	Implementation
Handbook		60	0	Deployment of IMT-2000 Systems	2003	Implementation IMT-2000
Rec.	M.	1078	0	Security principles for International Mobile Telecommunications-2000 (IMT-2000)	1994	Implementation IMT-2000
Rec.	M.	1223	0	Evaluation of security mechanisms for IMT-2000	1997	Implementation IMT-2000
Rec.	M.	687	2	International Mobile Telecommunications-2000 (IMT-2000)	1997	Objectives IMT-2000
Rep.	M.	1153	0	Future public land mobile telecommunication systems	1990	Objectives
Rec.	M.	1645	0	Framework and overall objectives of the future development of IMT-2000 and systems beyond IMT-2000	2003	Objectives IMT-2000
Rec.	M.	2083	0	IMT Vision – "Framework and overall objectives of the future development of IMT for 2020 and beyond"	2015	Objectives IMT-2020
Rec.	M.	1457	15	Detailed specifications of the terrestrial radio interfaces of International Mobile Telecommunications-2000 (IMT-2000)	2020	Radio interface specifications IMT-2000
Rec.	M.	2012	5	Detailed specifications of the terrestrial radio interfaces of International Mobile Telecommunications Advanced (IMT-Advanced)	2022	Radio interface specifications IMT-Advanced
Rec.	M.	2150	1	Detailed specifications of the terrestrial radio interfaces of International Mobile Telecommunications-2020 (IMT-2020)	2022	Radio interface specifications IMT-2020
Rec.	M.	1390	0	Methodology for the calculation of IMT-2000 terrestrial spectrum requirements	1999	Spectrum needs IMT-2000

Type	Series	Number	Rev.	Title	Year	Relevant topic(s)
Rec.	M.	1768	1	Methodology for calculation of spectrum requirements for the terrestrial component of International Mobile Telecommunications	2013	Spectrum needs
Rep.	M.	2023	0	Spectrum requirements for International Mobile Telecommunications-2000 (IMT-2000)	2000	Spectrum needs IMT-2000
Rep.	M.	2072	0	World mobile telecommunication market forecast	2005	Spectrum needs
Rep.	M.	2078	0	Estimated spectrum bandwidth requirements for the future development of IMT-2000 and IMT-Advanced	2006	Spectrum needs IMT-2000 / IMT-Advanced
Rep.	M.	2079	0	Technical and operational information for identifying spectrum for the terrestrial component of future development of IMT-2000 and IMT-Advanced	2006	Spectrum needs IMT-2000 / IMT-Advanced
Rep.	M.	2243	0	Assessment of the global mobile broadband deployments and forecasts for International Mobile Telecommunications	2011	Spectrum needs
Rep.	M.	2289	0	Future radio aspect parameters for use with the terrestrial IMT spectrum estimate methodology of Recommendation ITU-R M.1768-1	2013	Spectrum needs
Rep.	M.	2290	0	Future spectrum requirements estimate for terrestrial IMT	2013	Spectrum needs
Rep.	M.	2370	0	IMT Traffic estimates for the years 2020 to 2030	2015	Spectrum needs
Rec.	M.	1036	6	Frequency arrangements for implementation of the terrestrial component of International Mobile Telecommunications (IMT) in the bands identified for IMT in the Radio Regulations	2019	Spectrum usage Implementation
Rec.	M.	1456	0	Minimum performance characteristics and operational conditions for high altitude platform stations providing IMT-2000 in the bands 1 885-1 980 MHz, 2 010-2 025 MHz and 2 110-2 170 MHz in Regions 1 and 3 and 1 885-1 980 MHz and 2 110-2 160 MHz in Region 2	2000	Spectrum usage HAPS IMT-2000
Rec.	M.	1545	0	Measurement uncertainty as it applies to test limits for the terrestrial component of International Mobile Telecommunications-2000	2001	Spectrum usage IMT-2000
Rec.	M.	1635	0	General methodology for assessing the potential for interference between IMT-2000 or systems beyond IMT-2000 and other services	2003	Spectrum usage
Rec.	M.	1641	1	A methodology for co-channel interference evaluation to determine separation distance from a system using HAPS to a cellular system to provide IMT-2000 service	2006	Spectrum usage IMT-2000
Rec.	M.	1646	0	Parameters to be used in co-frequency sharing and pfd threshold studies between terrestrial IMT-2000 and BSS (sound) in the 2 630-2 655 MHz band	2003	Spectrum usage IMT-2000
Rec.	M.	1654	0	A methodology to assess interference from broadcasting satellite service (sound) into terrestrial IMT-2000 systems intending to use the band 2 630-2 655 MHz	2003	Spectrum usage IMT-2000
Rep.	M.	2024	0	Summary of spectrum usage survey results	2000	Spectrum usage

Type	Series	Number	Rev.	Title	Year	Relevant topic(s)
Rep.	M.	2030	0	Coexistence between IMT-2000 time division duplex and frequency division duplex radio interface technologies around 2 600 MHz operating in adjacent bands and in the same geographical area	2003	Spectrum usage IMT-2000
Rep.	M.	2031	0	Compatibility between WCDMA 1800 downlink and GSM 1900 uplink	2003	Spectrum usage
Rep.	M.	2039	3	Characteristics of terrestrial IMT-2000 systems for frequency sharing/interference analyses	2014	Spectrum usage
Rep.	M.	2041	0	Sharing and adjacent band compatibility in the 2.5 GHz band between the terrestrial and satellite components of IMT-2000	2003	Spectrum usage IMT-2000
Rep.	M.	2045	0	Mitigating techniques to address coexistence between IMT-2000 time division duplex and frequency division duplex radio interface technologies within the frequency range 2 500-2 690 MHz operating in adjacent bands and in the same geographical area	2004	Spectrum usage
Rec.	M.	2090	0	Specific unwanted emission limit of IMT mobile stations operating in the frequency band 694-790 MHz to facilitate protection of existing services in Region 1 in the frequency band 470-694 MHz	2015	Spectrum usage
Rec.	M.	2101	0	Modelling and simulation of IMT networks and systems for use in sharing and compatibility studies	2017	Spectrum usage
Rep.	M.	2109	0	Sharing studies between IMT-Advanced systems and geostationary satellite networks in the fixed satellite service in the 3 400-4 200 MHz and 4 500-4 800 MHz frequency bands	2007	Spectrum usage IMT-Advanced
Rep.	M.	2110	0	Sharing studies between radiocommunication services and IMT systems operating in the 450-470 MHz band	2007	Spectrum usage
Rep.	M.	2111	0	Sharing studies between IMT-Advanced and radiolocation service in the 3 400-3 700 MHz bands	2007	Spectrum usage IMT-Advanced
Rep.	M.	2112	0	Compatibility/sharing of airport surveillance radars and meteorological radar with IMT systems within the 2 700-2 900 MHz band	2007	Spectrum usage
Rep.	M.	2113	1	Sharing studies in the 2 500-2 690 MHz band between IMT-2000 and fixed broadband wireless access systems including nomadic applications in the same geographical area	2008	Spectrum usage IMT-2000
Rep.	M.	2146	0	Coexistence between IMT-2000 CDMA DS and IMT-2000 OFDMA TDD WMAN in the 2 500-2 690 MHz band operating in adjacent bands in the same area	2009	Spectrum usage
Rep.	M.	2241	0	Compatibility studies in relation to Resolution <b>224</b> in the bands 698-806 MHz and 790-862 MHz	2011	Spectrum usage
Rep.	M.	2292	0	Characteristics of terrestrial IMT-Advanced systems for frequency sharing/interference analyses	2013	Spectrum usage

Type	Series	Number	Rev.	Title	Year	Relevant topic(s)
Rep.	M.	2324	0	Sharing studies between potential International Mobile Telecommunication systems and aeronautical mobile telemetry systems in the frequency band 1 429-1 535 MHz	2014	Spectrum usage
Rep.	SA.	2325	0	Sharing between space-to-space links in space research, space operation and Earth exploration-satellite services and IMT systems in the frequency bands 2 025-2 110 MHz and 2 200-2 290 MHz	2014	Spectrum usage
Rep.	F.	2326	0	Sharing and compatibility study between indoor International Mobile Telecommunication small cells and fixed service station in the 5 925-6 425 MHz frequency band	2014	Spectrum usage
Rep.	F.	2327	0	Sharing and compatibility study between International Mobile Telecommunication systems and point-to-point fixed wireless systems in the frequency band 4 400-4 990 MHz	2014	Spectrum usage
Rep.	F.	2328	0	Sharing and compatibility between International Mobile Telecommunication systems and fixed service systems in the 3 400-4 200 MHz frequency range	2014	Spectrum usage
Rep.	SA.	2329	0	Sharing assessment between meteorological-satellite systems and IMT stations in the 1 695-1 710 MHz frequency band	2014	Spectrum usage
Rep.	F.	2331	0	Sharing and compatibility between International Mobile Telecommunication systems and fixed service systems in the 470-694/698 MHz frequency range	2014	Spectrum usage
Rep.	RA.	2332	0	Compatibility and sharing studies between the radio astronomy service and IMT systems in the frequency bands 608-614 MHz, 1 330-1 400 MHz, 1 400-1 427 MHz, 1 610.6-1 613.8 MHz, 1 660-1 670 MHz, 2 690-2 700 MHz, 4 800-4 990 MHz and 4 990-5 000 MHz	2014	Spectrum usage
Rep.	F.	2333	0	Sharing and compatibility study between International Mobile Telecommunication and the fixed service in the frequency band 1 350-1 527 MHz	2014	Spectrum usage
Rep.	RS.	2336	0	Consideration of the frequency bands 1 375-1 400 MHz and 1 427-1 452 MHz for the mobile service - Compatibility with systems of the Earth exploration-satellite service within the 1 400-1 427 MHz frequency band	2014	Spectrum usage
Rep.	BT.	2337	1	Sharing and compatibility studies between digital terrestrial television broadcasting and terrestrial mobile broadband applications, including IMT, in the frequency band 470-694/698 MHz	2017	Spectrum usage
Rep.	BT.	2338	0	Services ancillary to broadcasting/services ancillary to programme making spectrum use in Region 1 and the implication of a co-primary allocation for the mobile service in the frequency band 694-790 MHz	2014	Spectrum usage

Type	Series	Number	Rev.	Title	Year	Relevant topic(s)
Rep.	BT.	2339	0	Co-channel sharing and compatibility studies between digital terrestrial television broadcasting and International Mobile Telecommunication in the frequency band 694-790 MHz in the GE06 planning area	2014	Spectrum usage
Rep.	BS.	2340	0	Sharing between the mobile service and the broadcasting service in the 1 452-1 492 MHz frequency band	2014	Spectrum usage
Rep.	S.	2367	0	Sharing and compatibility between International Mobile Telecommunication systems and fixed-satellite service networks in 5 850-6 425 MHz frequency range	2015	Spectrum usage
Rep.	S.	2368	0	Sharing studies between International Mobile Telecommunication-Advanced systems and geostationary satellite networks in the fixed-satellite service in the 3 400-4 200 MHz and 4 500-4 800 MHz frequency bands in the WRC study cycle leading to WRC-15	2015	Spectrum usage
Rep.	M.	2374	0	Coexistence of two TDD networks in the 2 300-2 400 MHz band	2015	Spectrum usage
Rep.	M.	2499	0	Synchronization of IMT-2020 Time Division Duplex networks	2021	Spectrum usage
Rep.	M.	2481	0	In-band and adjacent band coexistence and compatibility studies between IMT systems in 3 300-3 400 MHz and radiolocation systems in 3 100-3 400 MHz	2019	Spectrum usage
Rep.	M.	2242	0	Cognitive radio systems specific for IMT systems	2011	Technology Spectrum usage
Rep.	M.	2244	0	Isolation between antennas of IMT base stations in the land mobile service	2011	Technology
Rep.	M.	2334	0	Passive and active antenna systems for base stations of IMT systems	2014	Technology
Rep.	M.	2376	0	Technical feasibility of IMT in bands above 6 GHz	2015	Technology Specifications and characteristics
Rep.	M.	2038	0	Technology trends	2003	Technology evolution
Rep.	M.	2074	0	Radio aspects for the terrestrial component of IMT-2000 and systems beyond IMT-2000	2006	Technology evolution
Rep.	M.	2320	0	Future technology trends of terrestrial IMT systems	2014	Technology evolution
Handbook		62	0	Global Trends in International Mobile Telecommunications	2015	Technology evolution
Rec.	M.	816	1	Framework for services supported on International Mobile Telecommunications-2000 (IMT-2000)	1997	Telecommunication services and applications IMT-2000
Rec.	M.	1079	2	Performance and quality of service requirements for International Mobile Telecommunications-2000 (IMT-2000) access networks	2003	Telecommunication services and applications IMT-2000
Rec.	M.	1822	0	Framework for services supported by IMT	2007	Telecommunication services and applications

Type	Series	Number	Rev.	Title	Year	Relevant topic(s)
Rep.	M.	2291	2	The use of International Mobile Telecommunications for broadband public protection and disaster relief applications	2021	Telecommunication services and applications
Rep.	M.	2373	1	Audio-visual capabilities and applications supported by terrestrial IMT systems	2018	Telecommunication services and applications
Rep.	M.	2440	0	The use of the terrestrial component of International Mobile Telecommunications (IMT) for narrowband and broadband machine-type communications	2018	Telecommunication services and applications
Rep.	M.	2441	0	Emerging usage of the terrestrial component of International Mobile Telecommunication (IMT)	2018	Telecommunication services and applications
Rec.	M.	1580	5	Generic unwanted emission characteristics of base stations using the terrestrial radio interfaces of IMT-2000	2014	Unwanted emissions IMT-2000
Rec.	M.	1581	5	Generic unwanted emission characteristics of mobile stations using the terrestrial radio interfaces of IMT-2000	2014	Unwanted emissions IMT-2000
Rec.	M.	2070	1	Generic unwanted emission characteristics of base stations using the terrestrial radio interfaces of IMT-Advanced	2017	Unwanted emissions IMT-Advanced
Rec.	M.	2071	1	Generic unwanted emission characteristics of mobile stations using the terrestrial radio interfaces of IMT-Advanced	2017	Unwanted emissions IMT-Advanced

### F.3 Work ongoing and underway in ITU-R WP5D

For the latest ongoing activities of ITU-R WP5D refer to the latest chairman's report: <https://www.itu.int/ITU-R/go/rwp5d/>

### F.4 All list of ITU-R Recommendations and Reports on IMT

For a complete up-to-date list of published Recommendations, Reports and Handbooks on the terrestrial component of IMT, refer to the [Guide to the use of the ITU-R texts relating to the terrestrial component of IMT](https://www.itu.int/oth/R0A060000AA/en): <https://www.itu.int/oth/R0A060000AA/en>

## ANNEX G

## Technology migration in a given frequency band

## G.1 Frequency resource assignments

Two frequency assignment modes are available, depending on the operator's spectrum resource usage: edge frequency assignment and sandwich frequency assignment. These schemes are depicted in Figure 27.

FIGURE 27

## Multi-RAT frequency assignments

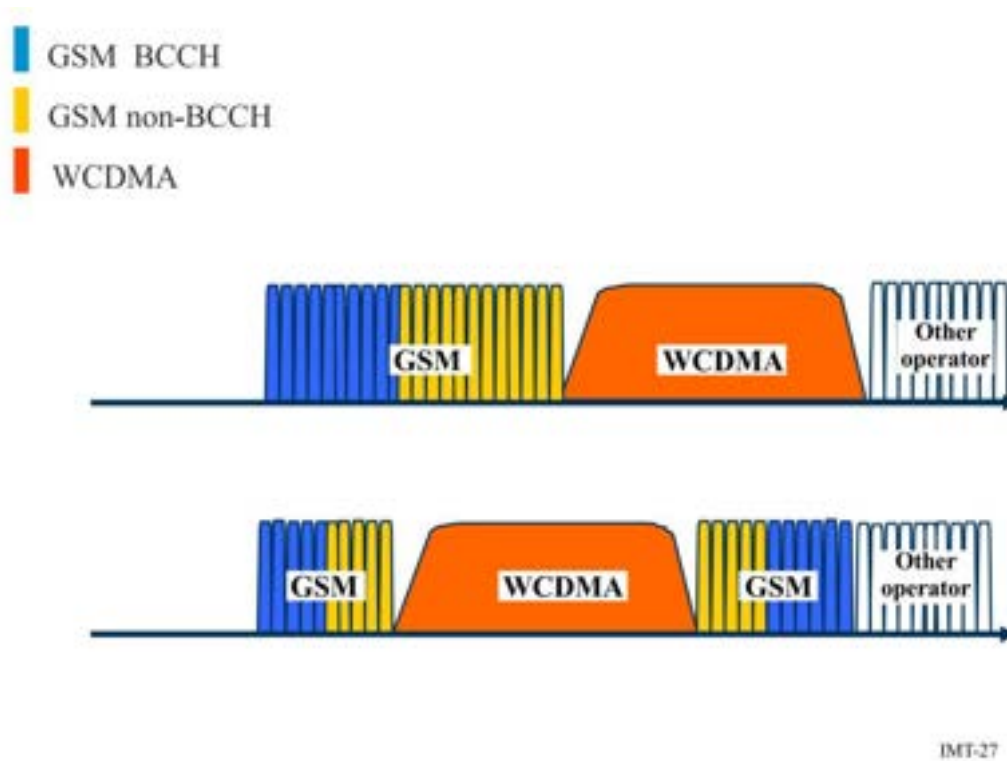
*Edge Frequency Assignment*

The UMTS/LTE and GSM systems are arranged side-by-side and maintain standard central frequency separation from the UMTS/LTE and GSM of other operators.

*Sandwich Frequency Assignment*

Within the frequency band of an operator, the UMTS/LTE is arranged in the middle with the GSM on both sides. If the operator has abundant frequency resources, it may assign a second UMTS carrier or bigger bandwidth LTE as network services expand. At this point, the UMTS/LTE can be arranged at one side of the operator's frequency band for asymmetric sandwich assignment. The GSM spectrum at the other side is as wide as possible, and thus the UMTS/LTE planned does not require adjustment, which facilitates smooth capacity expansion.

For the single sided method, only one additional guard band is needed while in the sandwich assignment two additional guard bands are needed. The sandwich assignment does not require the consideration of interference with the systems of other operators.

**Non-standard frequency separation planning**

Due to limited frequency resources and high GSM capacity demand, non-standard frequency separation can be adopted to increase frequency efficiency.

In UMTS 900 MHz network, the bandwidth may be less than 5 MHz because of smaller frequency resource from GSM network. Thus, non-standard frequency separation is adopted. And UMTS 4.2 MHz is the recommended solution for both UMTS network deployment feasibility and the benefit to GSM. Besides, UMTS 4.6 MHz, 3.8 MHz also is possible to be adopted. In Figure 28, when using UMTS non-standard bandwidth 4.6 MHz, 4.2 MHz, 3.8 MHz; 2, 4, 6 frequency channels can be saved for GSM correspondingly.

It is possible to operate WCDMA with a carrier as low as 4.2 MHz. However, it should be noted that even though a bandwidth less than 5 MHz is not standardized for MS or RBS (Radio Base Station), it only implies minimal loss of capacity for WCDMA.

The sandwich assignment method is the preferred solution if 4.2 MHz is assigned for WCDMA. In that case it is preferable to use WCDMA carrier centred in own spectrum to avoid un-coordinated scenarios with other operators.

FIGURE 28

**UMTS non-standard separation configuration**

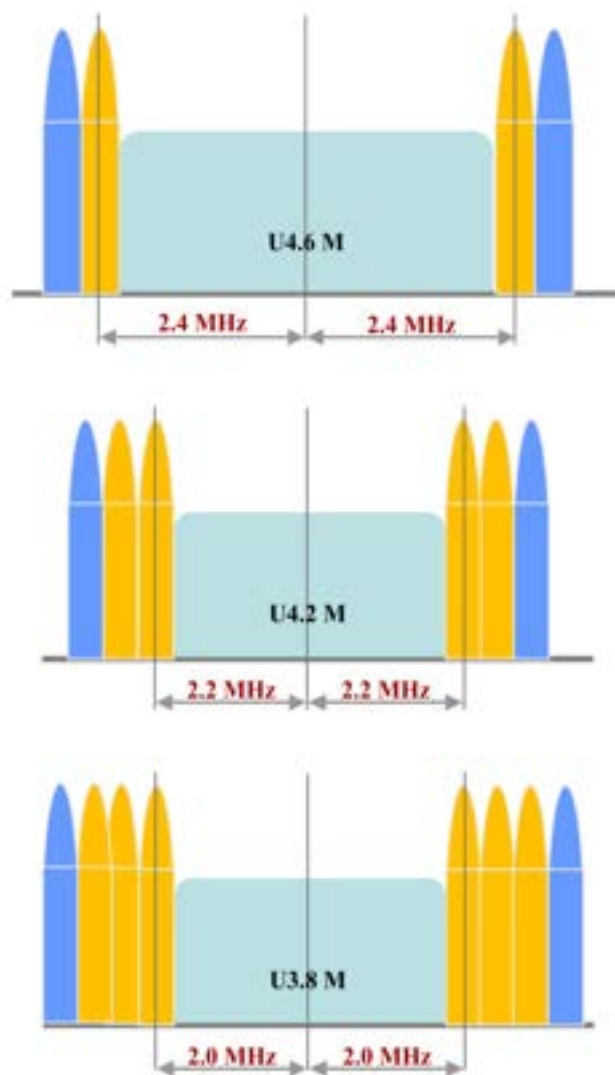



For 1 800 MHz bands which preferable re-farming direction is LTE, a similar issue exists. If 1 800 MHz frequency resource owned by one operator is insufficient, Compact Bandwidth can be enabled so that the LTE1800 network can be deployed by re-farming from GSM networks.

GSM frequency resources are substantially reduced after re-farming. GSM traffic will not fall in the short term, however, and in some areas may even increase slightly. This may result in capacity issues of GSM system. This issue may be addressed through traffic migration and tight frequency reuse.

### Buffer zone solution

In the case of GSM and UMTS/LTE co-channel interference, a space separation is required to reduce the co-channel interference as illustrated in Figure 29 below. Areas with UMTS/LTE networks deployed and their peripheral areas form a band-type area. In this area, GSM networks cannot use frequencies overlapped in UMTS/LTE frequency spectrums and therefore GSM network capacity decreases. A large space separation for co-channel interference decreases impacts of GSM and UMTS/LTE co-channel interference on network performance. For space separation for co-channel interference, buffer zone planning solution is based on emulation and onsite traffic statistics to accommodate different scenarios.

FIGURE 29

### Buffer zone solution

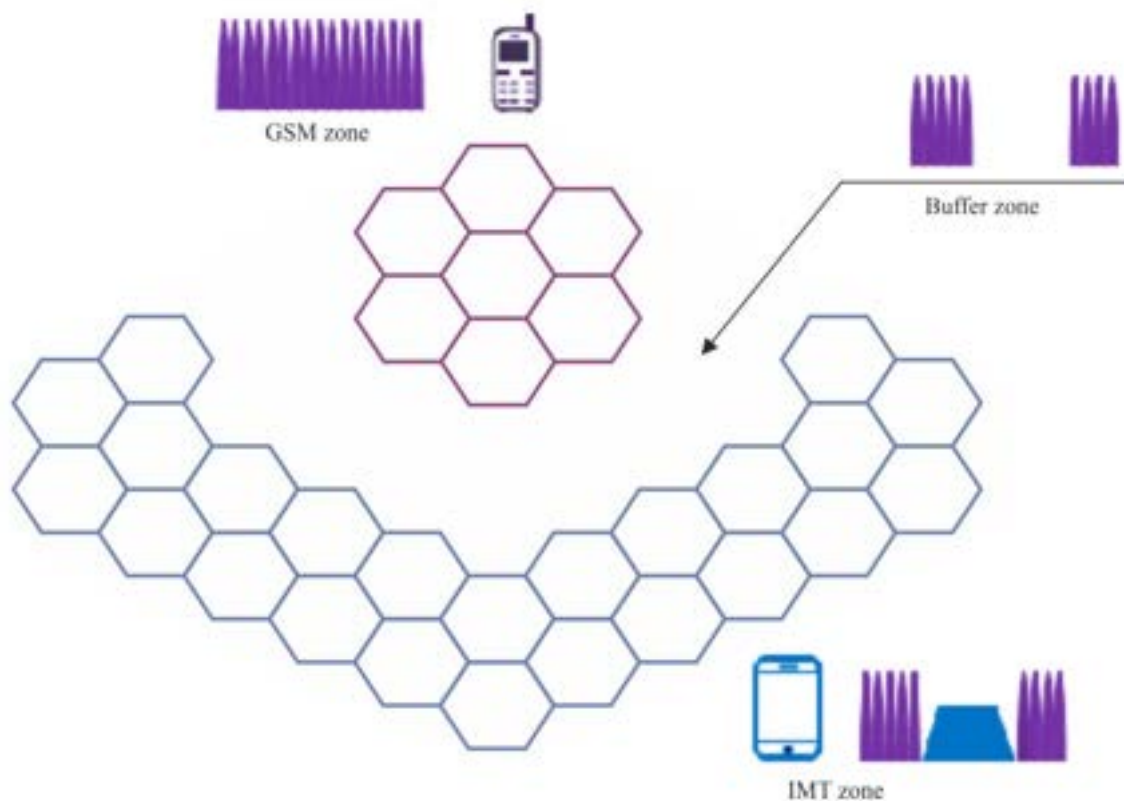

## G.2 Coexistence between GSM and IMT in the adjacent frequencies

### G.2.1 Interference and intermodulation issues

#### Interference

When GSM re-farming is implemented, except for interference between GSM and UMTS/LTE under standard separation or non-standard separation, narrow band interference in UMTS/LTE network is stricter. The narrow band interference may be from GSM TRXs that are not cleared completely, or may be from external interference source, like traffic light, broadcast signal, etc. These interference signals are not constant, and their strength is variable.

#### Intermodulation

Intermodulation problems can occur after GSM re-farming, when GSM will coexist with UMTS or LTE in one band. The intermodulation may be caused by antenna aging, feeder/jumper connection loose, etc., which will also exist in all other RAT combinations as well (as well as single RAT GSM operation).

#### Guard band and carrier separation

The definition of guard band and carrier separation used in this document is shown in Figure 30 below.

FIGURE 30

Carrier separation and guard band

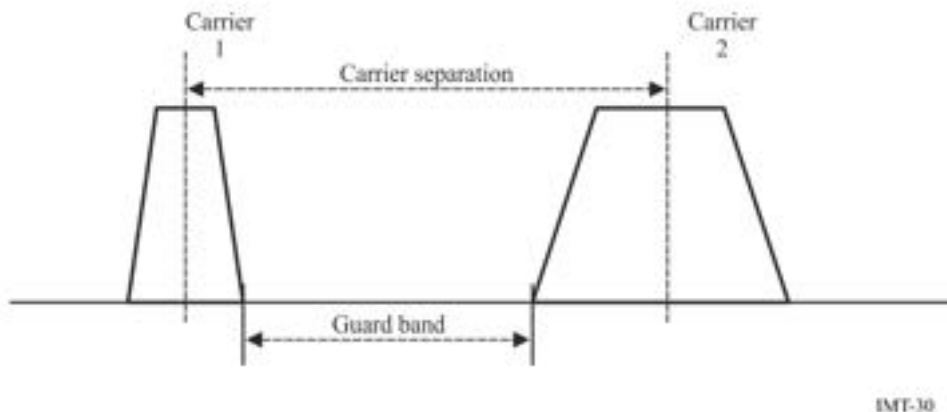

Carrier separation: the frequency band between two carrier centres.

Guard band: the unutilized frequency band between two carriers.

### G.2.2 Coexistence between GSM and WCDMA

An example of Sharing/Coexistence between GSM and WCDMA in the adjacent frequencies is presented in Figure 31. Given an operator that will deploy WCDMA within its current limited GSM spectrum the issues can be summarized as:

- Re-farming of many GSM carriers makes the GSM frequency re-planning “difficult” but creates “few” inter-system interference issues (case a) below).
- Re-farming of few GSM carriers makes the GSM frequency re-planning “easy” but creates “severe” inter-system interference issues (case b) below).

FIGURE 31  
Two Re-farming scenarios

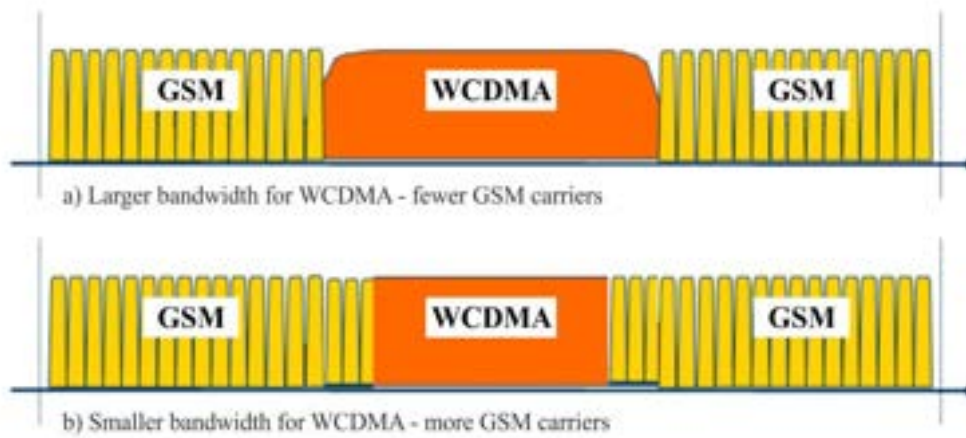

IMT-31

**G.2.2.1 Interference and site scenarios**

Due to the imperfectness of the transmitter and/or receiver we may list some interference scenarios on how GSM and WCDMA interfere with each other.

FIGURE 32  
What and where the potential problems are

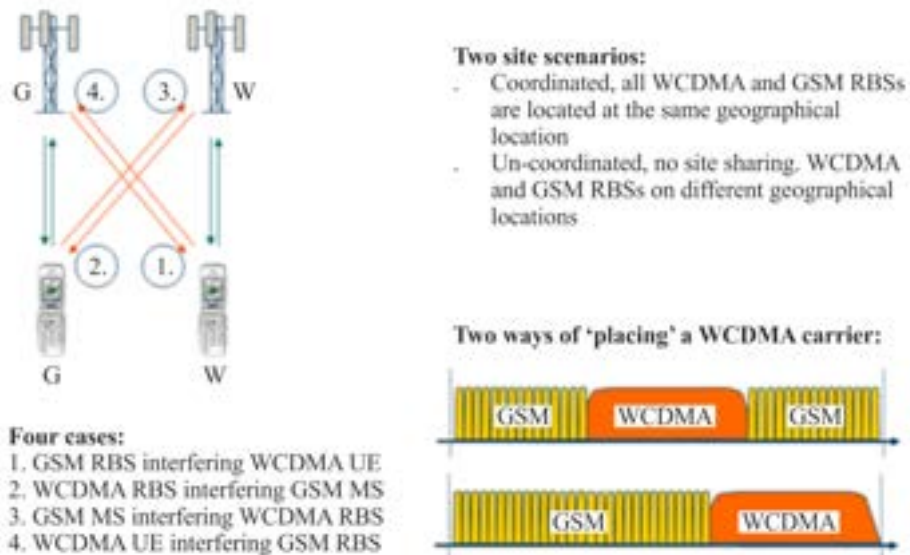

IMT-32

As Figure 32 is illustrating, there are four important interference cases

- GSM downlink interfering with the WCDMA downlink
- WCDMA downlink interfering with the GSM downlink
- GSM uplink interfering with the WCDMA uplink
- WCDMA uplink interfering with the GSM uplink.

In addition there are two site scenarios to consider:

- Coordinated sites, i.e. the WCDMA and GSM antennas are co-located
- Un-coordinated sites, i.e. there is no site sharing.

#### **G.2.2.2 WCDMA Downlink capacity loss due to GSM**

The WCDMA DL (Downlink) capacity loss is controlled by the WCDMA terminal channel selectivity requiring at least a 2.8 MHz separation.

It is therefore difficult to make a prediction about performance if the carrier separation is decreased. However, regardless of the terminal performance, at a channel separation of 2.2-2.3 MHz the channel leakage increases dramatically and would make it very difficult indeed to operate with this kind of channel separation.

However, if the GSM channel power is sufficiently controlled and the traffic load is small it is possible to operate at a tolerable impact on the DL capacity.

One way of achieving this is to make sure that the GSM channels that overlap the WCDMA carrier (have spacing smaller than 2.6 MHz) are used in a low traffic sub-cell layer and aggressive BTS power control is used (and hence the impact on the DL WCDMA capacity also minimized).

#### **G.2.2.3 WCDMA Uplink capacity loss due to GSM**

The WCDMA UL (Uplink) capacity loss is assumed to be controlled by the GSM terminal channel leakage. The GSM channel leakage behaves acceptable until 2.2-2.3 MHz carrier spacing, below which it becomes very difficult to operate.

Note that GSM terminals have a limited dynamic range for power control and at some small path loss they simply do not down regulate anymore. This implies that a single GSM terminal can cause severe WCDMA UL noise rise and corresponding severe degradation in coverage.

The remedy here is to make sure that the load on overlapping carriers (any carrier with a channel separation to the WCDMA carrier lower than say 2.4 MHz) must be very low indeed.

Another remedy is to avoid using these GSM carriers close to the base station.

#### **G.2.2.4 GSM Uplink capacity loss due to WCDMA**

The GSM UL performance is controlled by the WCDMA terminal channel leakage which is insignificant for a 2.8 MHz carrier separation.

From the specification data the critical point comes below 2.5-2.6 MHz separation where the channel leakage suddenly increases.

The GSM UL performance should degrade at channel separation below 2.5 MHz, however given that WCDMA terminals have a much larger dynamic range in their power control it is a much less impacting effect than the one expected in WCDMA UL loss and the GSM UL performance on channels overlapping the WCDMA carrier is not significantly affected.

#### **G.2.2.5 GSM Downlink capacity loss due to WCDMA**

The GSM DL outage is insignificant for a 2.8 MHz carrier separation.

Assuming that the WCDMA base station controls the GSM DL performance at smaller channel separations a critical point appears to be at channel spacing around 2.5-2.6 MHz. Going below that seems to be very difficult.

#### **G.2.2.6 Summary**

The preferred scenario is to use coordinated GSM and WCDMA sites and the WCDMA carrier sandwiched in-between GSM carriers. The closest/overlapping GSM carriers should be TCH (Traffic Channel) only (not a BCCH-Broadcast Control Channel- carrier), having the smallest traffic load possible and aggressive power control. This setup allows the use of a carrier spacing as low as 2.5 MHz with low performance degradation both on WCDMA and GSM.

### G.3 Coexistence of various GSM/CDMA-MC/UMTS/LTE technologies in 850 and 900 MHz bands

Although initially the 900 MHz band spectrum (UL: 880-915 MHz, DL: 925-960 MHz) was used for GSM technology, at present in many countries this band is also being used for UMTS and LTE technologies. Similarly, the 850 MHz band spectrum (UL: 824-849 MHz, DL: 869-894 MHz) is initially used for CDMA-MC technology and now it is also being used for UMTS and LTE technologies, as a replacement. Because of the closeness between the 850 MHz band downlink spectrum with the 900 MHz band uplink spectrum, there is higher possibility for inter-band interference issues. Also due to multiple technologies being used with the 850/900 MHz band spectrum, there is a possibility for intra-band interference issues happening within the 850/900 MHz band spectrum. While collocated/coordinated deployments solve most of the intra-band interference issues, the inter-band interference issues would exist in both collocated/non-collocated deployment scenarios. The inter-band interference issues between the 850 MHz band downlink and the 900 MHz band uplink at 880/890 MHz boundary are very severe in nature and needs special attention to solve those interference issues.

With CDMA, UMTS and LTE technologies being used in the 850 MHz band (assuming GSM850 possibility in Asia-Pacific region is very remote) and any of the GSM, UMTS and LTE technologies being used in the 900 MHz band (as shown in Figure 33), the following types of inter-band interference issues are observed between the 850 MHz band downlink and the 900 MHz band uplink at 880/890 MHz boundary:

- CDMA/UMTS/LTE850 base station transmission affecting the reception performance of GSM/UMTS/LTE900 base station (900 MHz band uplink is getting affected).
- GSM/UMTS/LTE900 mobile transmission affecting the reception performance of the CDMA/UMTS/LTE850 mobile (850 MHz band downlink is getting affected).

FIGURE 33

#### Inter-band interference issues between 850 and 900 MHz bands systems

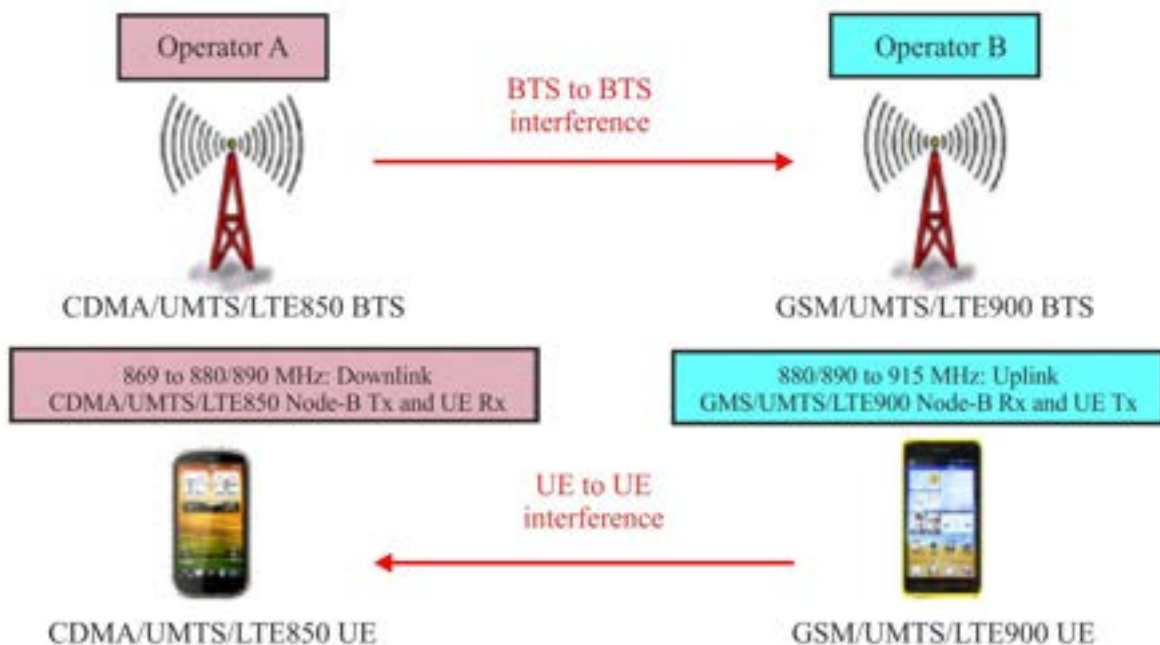

### G.3.1 Inter-band and intra-band interference issues between 850 and 900 MHz bands

The inter-band interference issues are mainly either downlink-uplink or uplink-downlink type of interference issues and they are more severe in nature. This type of interference issues are difficult to deal with because they would generally lead to performance degradation if not tackled properly. There are two types of inter-band interference issues and they are:

- Downlink Tx of the last 850 MHz band carrier (base station transmit) affecting the first 900 MHz band carrier's Uplink Rx (base station receive);
- First 900 MHz band carrier's Uplink Tx (mobile transmit) affecting the last 850 MHz band carrier's Downlink Rx (mobile receive).

The two major interference issues with aggressors transmit affecting victim's receiver are:

- Out-of-band emissions (OOBE) of the aggressor signal entering as in-band interference that can degrade the uplink performance at the victim's receiver.
- High power adjacent channel signal of the aggressor acting as strong Adjacent Channel Interference (ACI) which may desensitize the victim's receiver.

While the OOBE type of interference can only be minimized at the source (at the aggressor's transmitter) by improving the Adjacent Channel Leakage Ratio (ACLR) properties of the Aggressor through additional transmit filtering, the ACI type of interference can be minimized at the destination (at the victim's receiver) by having better Adjacent Channel Selectivity (ACS) properties of the Victim through additional receive filtering. To get the required additional ACLR/ACS characteristics, extra filtering is possible in the base stations. Whereas, for cost and space reasons it may not be possible to have such additional filters in mobiles.

Minimum Coupling Loss (MCL) based approach can be used to calculate the amount of isolation required to counter the effect of out-of-band emissions as well as the adjacent channel interference of the aggressor. The required isolation in base station to base station inter-band interference issues is achieved partly through spatial isolation from physical separation of antennas and remaining through special filters in Aggressor's transmit and Victim's receive paths.

In the inter-band interference issues case, there are two different problems, one with the 850 MHz band base station transmit signal affecting the performance of the 900 MHz band base station receive and the other with the 900 MHz band mobile transmit affecting the performance of the 850 MHz band mobile receive. In case of less than 90 dB of antenna isolation availability between the 850 MHz band base station and the 900 MHz band base station antennas, assuming always 10 to 15 dB (more than the standards required value) of additional ACLR and ACS would be available for base stations, then there is a need for additional 30+ dB of ACLR (through OOBE filtering) in the 850 MHz band base station Tx path as well as additional 20+ dB of ACS (through ACI filtering) in the 900 MHz band base stations' Rx path.

In the case of the 900 MHz band mobile Tx affecting the 850 MHz band mobile Rx, interference free operation is not possible as the additional ACLR/ACS requirement is high and also it is not possible (cost and space point-of-view) to have additional filters in mobiles. However, the probability of mobile to mobile interference happening is very low, because the conditions that two close by 900 MHz band and 850 MHz band mobiles simultaneously in active state and both in weak coverage state is very rare. Even though there is no additional filtering solution possible in mobiles (no mitigation solution available for the aggressor mobile Tx interference on victim mobile Rx), due to very low probability of such mobile-to-mobile interference happening (less than 2%), the victim downlink degradation possibility would also be very less.

Hence, to avoid inter-band interference issues, it is advisable (to the mobile wireless operators) to procure base station equipment along with such additional filtering in all UMTS850 and UMTS900 and LTE900 systems at the time of initial purchase itself. If not done during initial purchase, it is also possible to add these additional filters at a later stage.

As new IMT (e.g. UMTS, LTE) technologies gets introduced into the 900 MHz band spectrum as an overlay over the existing GSM technology deployments by carving out some spectrum, special care has to be taken by the operators on two fronts. One is choosing the right technology for the overlay and the other is the amount of spectrum to be carved out for the new technology. Also to be kept in mind is the knowhow on the possible intra-band interference issues and the ways and means to tackle such interference issues.

The intra-band interference issues can occur between two technologies operating in adjacent slots of the spectrum, especially when the base stations of these two technologies are deployed in an uncoordinated fashion. In the overlay with new technology scenario, it is going to be mostly a coordinated deployment and hence no intra-band interference issues. There is a slight advantage for UMTS900 overlay over the LTE900 overlay (in coordinated case), because of the additional guard band availability with a 5 MHz UMTS900 carrier, that allows two extra GSM (TCH) carriers in each side of the UMTS900 carrier (i.e. total of four GSM carriers), compared to no extra GSM carriers possible with a 5 MHz LTE900 carrier. In an un-coordinated (non-located) base station deployment (at the edge of operator's spectrum) case, for minimal intra-band interference; 5 MHz of spectrum is required to be carved out for a UMTS900 carrier and 5.2 MHz of spectrum is required to be carved out for an LTE900 carrier.

### G.3.2 Guard band requirement in inter-band case for cost-effective filtering

Sufficient guard band (GB) between two inter-band systems is required to not only achieve the standards based ACLR and ACS values but also to have cost-effective filters in order to achieve additional isolation to fulfil the total isolation requirement for interference free operation. For cost effective filtering in base stations, nearly 1.6 to 2.0 MHz of guard band is required between the two inter-band adjacent carriers. Any additional GB is always good to have, as it would further help in getting increased isolation from filters at lesser cost, but it would lead to spectrum wastage. Table 6 shown below gives suggested edge-to-edge separation (guard band) in MHz between two adjacent aggressor and victim carriers. We assume, it is cost effectively possible to get the required additional ACLR (up to 50 dB) for OOB isolation and the required additional ACS (up to 35 dB) for ACI isolation through special filters, with such amounts of GB provision.

TABLE 6

Suggested inter-band guard band between 850 and 900 MHz Bands carriers<sup>56</sup>

Technology in 850 MHz band	Technology in 900 MHz band	Suggested edge-to-edge separation (Guard band in MHz)
CDMA (1.23 MHz)	GSM (200 kHz)	1.6
CDMA (1.23 MHz)	UMTS (5 MHz)	1.6
CDMA (1.23 MHz)	LTE (5/10/15/20 MHz)	1.8/2.1/2.5/3.0
UMTS (5 MHz)	GSM (200 kHz)	1.6
UMTS (5 MHz)	UMTS (5 MHz)	1.6
UMTS (5 MHz)	LTE (5/10/15/20 MHz)	1.6/1.9/2.3/2.8
LTE (5/10/15/20 MHz)	GSM (200 kHz)	1.8/2.1/2.5/3.0
LTE (5/10/15/20 MHz)	UMTS (5 MHz)	1.6/1.9/2.3/2.8
LTE (5/10/15/20 MHz)	LTE (5/10/15/20 MHz)	1.8/2.1/2.5/3.0

### G.4 Coexistence studies from CEPT between GSM and other systems

When the European Commission issued a mandate to CEPT on the technical conditions for allowing LTE and possibly other technologies within the bands 880-915 MHz / 925-960 MHz and 1 710-1 785 MHz /

<sup>56</sup> This is based on the assumption of antenna isolation of 60 dB. For more detailed information please refer to APT-AWG-REP-53 MIGRATION STRATEGY OF GSM TO MOBILE BROADBAND, September 2014.

1 805-1 880 MHz (900/1 800 MHz bands), it has been studied the technical conditions under which LTE technology (and other technology identified) can be deployed in the 900/1 800 MHz bands.

CEPT Report 40 (“in band”)<sup>57</sup> summarized the compatibility study for LTE and WiMAX operating within the bands 880-915 MHz / 925-960 MHz and 1 710-1 785 MHz / 1 805-1 880 MHz (900/1 800 MHz bands).

Based on the analysis of the simulation results of the interference between LTE/WiMAX and GSM, the frequency separation between the LTE/WiMAX channel edge and the nearest GSM carrier’s channel edge is derived as follows:

- When LTE/WiMAX networks in 900/1 800 MHz band and GSM900/1 800 networks are in uncoordinated operation, the recommended frequency separation between the LTE/WiMAX channel edge and the nearest GSM carrier’s channel edge is 200 kHz or more.
- When LTE/WiMAX networks in 900/1 800 MHz band and GSM900/1 800 networks are in coordinated operation (co-located sites), no frequency separation is required between the LTE/WiMAX channel edge and the nearest GSM carrier’s channel edge.
- The recommended frequency separation of 200 kHz or more for the uncoordinated operation can be reduced based on agreement between network operators, bearing in mind that the LTE/WiMAX wideband system may suffer some interference from GSM due to LTE/WiMAX BS/UE receiver narrow band blocking effect.

CEPT Report 41 (“adjacent band”)<sup>58</sup> summarized compatibility study between LTE and WiMAX operating within the bands 880-915 MHz / 925-960 MHz and 1 710-1 785 MHz/1 805-1 880 MHz (900/1 800 MHz bands) and systems operating in adjacent bands

CEPT Report 42<sup>59</sup> summarized the investigation on compatibility between UMTS and adjacent band systems above 960 MHz. The Report focuses on the compatibility between UMTS 900 on the one hand, and the aeronautical systems (existing: DME and future: L-DACS) in the band 960-1 215/1 164 MHz

---

---

<sup>57</sup> CEPT Report 40, Compatibility study for LTE and WiMAX operating within the bands 880-915 MHz/925-960 MHz and 1 710-1 785 MHz/1 805-1 880 MHz (900/1 800 MHz bands).

<sup>58</sup> CEPT Report 41, Compatibility between LTE and WiMAX operating within the bands 880-915 MHz/925-960 MHz and 1 710-1 785 MHz/1 805-1 880 MHz (900/1 800 MHz bands) and systems operating in adjacent bands.

<sup>59</sup> CEPT Report 42, Compatibility between UMTS and existing and planned aeronautical systems above 960 MHz.





International  
Telecommunication  
Union  
Place des Nations  
CH-1211 Geneva 20  
Switzerland

ISBN: 978-92-61-36421-2 SAP id



Published in Switzerland  
Geneva, 2022  
Photo credits: Shutterstock